



FAG



**added
competence**

High Precision Bearings for Combined Loads

**Axial/radial bearings
Axial angular contact ball bearings
Axial/radial bearings with angular measuring system**

SCHAEFFLER



**added
competence**

**“added competence”
for your success**

With their forward-looking bearing arrangement solutions for feed spindles, main spindles, rotary tables and linear guidance units, INA and FAG have been at the forefront of the world market for decades. Nevertheless, bearing components alone are often no longer the decisive factor for the success of these machine subsystems.

Indeed, our customers are continuing to benefit directly from significant performance improvements and unique selling points thanks to our “ready-to-fit” products, since these follow the efficient basic concept: unpack, screw mount, use. In order to optimise the entire machine tool system, however, it is also becoming ever more important to integrate important functions such as measurement, sealing, lubrication, braking etc. in the components themselves. This intellectual approach is fulfilled comprehensively by the new concept “added competence” in the Business Unit Production Machinery since it attaches central importance to systems solution thinking for the bearing, bearing position and entire system. This means that you can now access a product range that gives optimum coverage for all your applications in the machine tool.

In addition, there is increasingly frequent usage of direct drives and mechatronic solutions in machine tools. We have therefore incorporated IDAM – INA Drives & Mechatronics – as a further strong partner in our provider network. In this way, we can now supply you from a single source with not only bearing elements but also components precisely matched to the drive system.

This opens up completely new technical and economic design possibilities for your requirements as well as significant advantages in the time and process chain.

In terms of products, we can offer you a comprehensive, precisely balanced range, precision technology and top product quality. In order to match the pulse of your developments as closely as possible, we also have a worldwide network of engineers and service and sales technicians working for you and ensuring that we maintain close contact with you in your own location.

We are therefore confident that we have the right product for you, from a robust individual component right through to the defining high end system solution.

Perhaps you would like to talk to us about this?

**added
competence**

High precision bearings for combined loads

Axial/radial bearings 4

Axial/radial bearings are double direction axial bearings for screw mounting, with a radial guidance bearing. These ready-to-fit, pregreased units are very rigid, have high load carrying capacity and run with particularly high accuracy. They can support radial forces, axial forces from both directions and tilting moments free from clearance. The bearings are available in several series.

For applications with low speeds and small operating durations, such as indexing tables and swivel type milling heads, the most suitable bearing is generally series YRT.

For the bearing arrangements of direct drive axes, there is the series YRTS. Due to their high limiting speeds and very low, uniform frictional torque across the whole speed range, these bearings are particularly suitable for combination with torque motors.

For higher accuracy requirements, these bearings are also available with restricted axial and radial runout accuracy.

Axial angular contact ball bearings 4

Axial angular contact ball bearings ZKLDF are low-friction, ready-to-fit, pregreased bearing units with high accuracy for very high speeds, high axial and radial loads and high demands on tilting rigidity.

Axial angular contact ball bearings are particularly suitable for precision applications involving combined loads. Their preferred areas of use are bearing arrangements in rotary tables with a main spindle function, for example in combined milling and turning, as well as in milling, grinding and honing heads and in measurement and testing equipment.

Axial/radial bearings with angular measuring system 42

Axial/radial bearings with angular measuring system YRTM and YRTSM correspond in mechanical terms to series YRT and YRTS but are additionally fitted with an angular measuring system. The measuring system can measure angles to an accuracy of a few angular seconds by non-contact, magneto-resistive means.



YRT

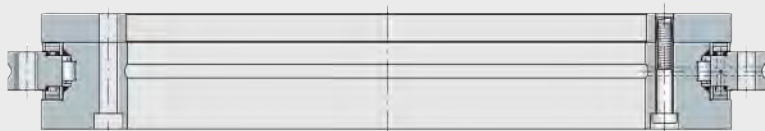

YRTS

000183EC



ZKLDf

107585

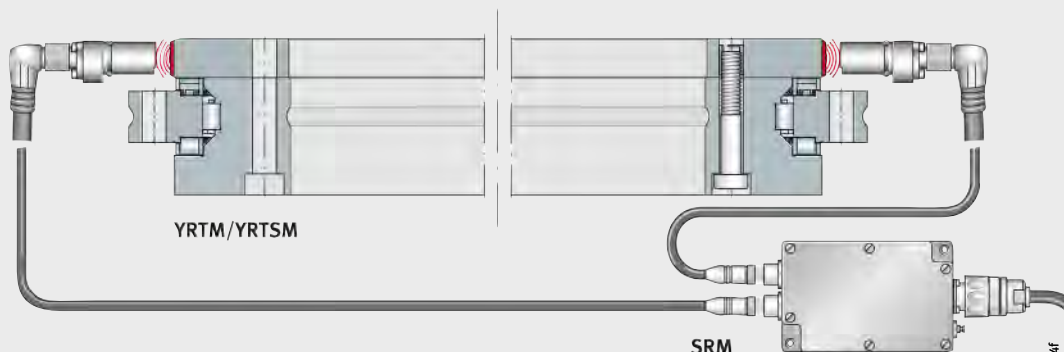

YRTM/YRTSM

SRM

0001484f



FAG

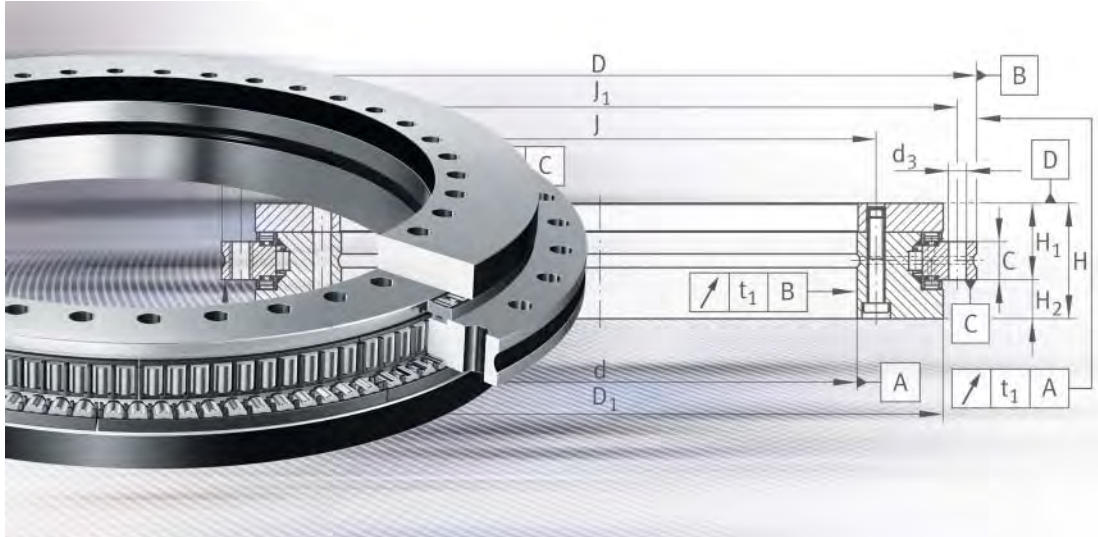

Axial/radial bearings
Axial angular contact ball bearings

Axial/radial bearings

Axial angular contact ball bearings

	Page
Product overview	Axial/radial bearings, axial angular contact ball bearings 6
Features	With angular measuring system 7
	Areas of application..... 7
	Axial/radial bearings 8
	Axial angular contact ball bearings 8
	Operating temperature 8
	Suffixes 8
Design and safety guidelines	General safety guidelines 9
	Basic rating life 10
	Static load safety factor 10
	Static limiting load diagrams 10
	Limiting speeds 14
	Temperature distribution in the rotary axis system 15
	Bearing preload 17
	Frictional torque 17
	Relubrication and initial operation 19
	Design of adjacent construction 21
	Fits 22
	L-section ring without support ring or with support ring 26
	Improved ease of mounting 28
	Fitting..... 29
	Static rigidity 30
Accuracy 31
Dimension tables	Axial/radial bearings, double direction, YRT 34
	Axial/radial bearings, double direction, YRTS 38
	Axial angular contact ball bearings, double direction, ZKLDF 40

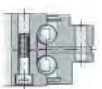
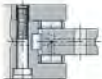

Product overview

Axial/radial bearings

Axial angular contact ball bearings

Axial/radial bearings

YRT

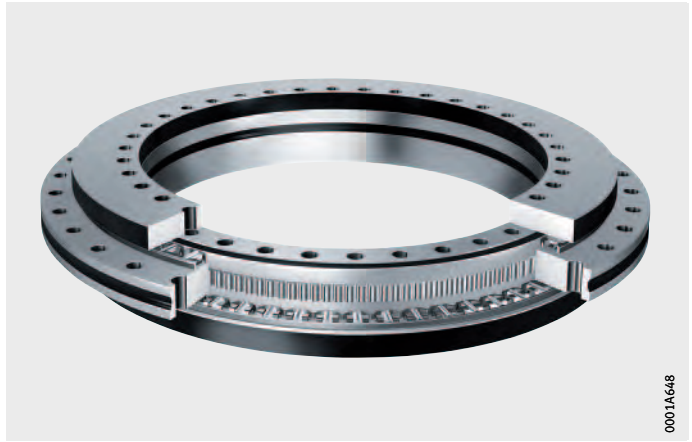

0001A648

For higher speeds

YRTS

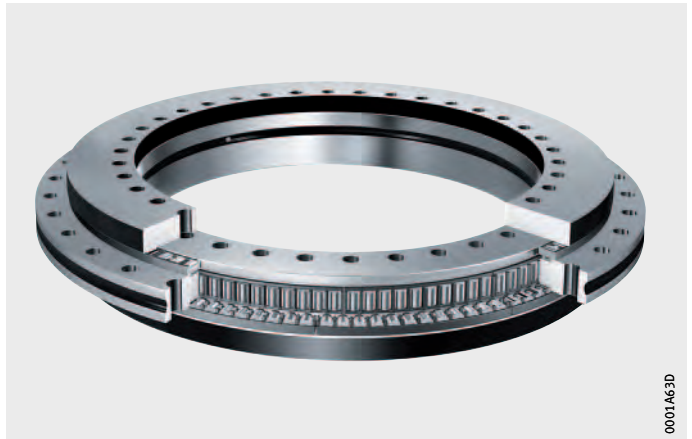

0001A63D

Axial angular contact ball bearings

ZKLDF



0001A63E

Axial/radial bearings

Axial angular contact ball bearings

Features

Axial/radial bearings YRT and YRTS and axial angular contact ball bearings ZKLDF are ready-to-fit high precision bearings for high precision applications with combined loads. They can support radial loads, axial loads from both sides and tilting moments without clearance and are particularly suitable for bearing arrangements with high requirements for running accuracy.

Due to the fixing holes in the bearing rings, the units are very easy to fit.

The bearings are radially and axially preloaded after fitting.

The mounting dimensions of all series are identical.

With angular measuring system

Axial/radial bearings are also available with an angular measuring system. The measuring system can measure angles to an accuracy of a few angular seconds by non-contact, magneto-resistive means, see chapter Axial/radial bearings with angular measuring system, page 42.



Areas of application

For standard applications with low speeds and small operating durations, such as indexing tables and swivel type milling heads, the most suitable bearing is generally series YRT, *Figure 1*.

For the bearing arrangements of direct drive axes, there is the series YRTS. Due to their high limiting speeds and very low, uniform frictional torque across the whole speed range, these bearings are particularly suitable for combination with torque motors, *Figure 1*.

For higher accuracy requirements, these bearings are also available with restricted axial and radial runout accuracy.

Axial angular contact ball bearings ZKLDF are particularly suitable for high speed applications with long operating duration, *Figure 1*. They are characterised by high tilting rigidity, low friction and low lubricant consumption.

n_G = limiting speed
 c_{kL} = tilting rigidity

- ① ZKLDF
- ② YRTS
- ③ YRT

Figure 1
 Speed and tilting rigidity

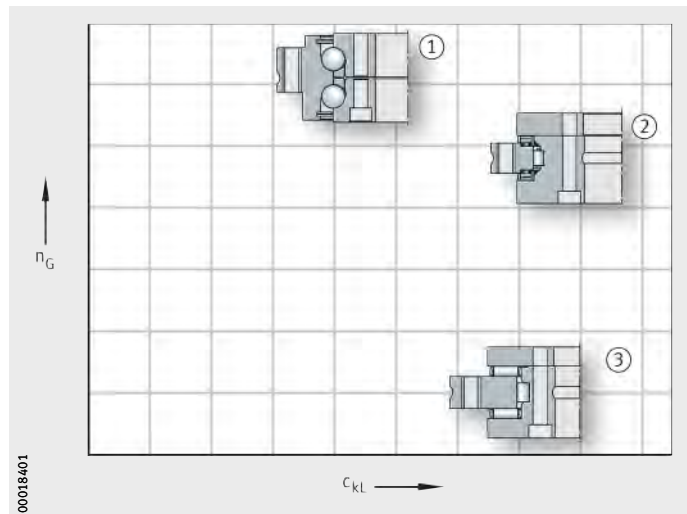

Axial/radial bearings

Axial angular contact ball bearings

Axial/radial bearings

Axial/radial bearings YRT and YRTS have an axial component and a radial component.

The axial component comprises an axial needle roller or cylindrical roller and cage assembly, an outer ring, L-section ring and shaft locating washer and is axially preloaded after fitting. The radial component is a full complement cylindrical roller set in YRT and a cage-guided, preloaded cylindrical roller set in YRTS. The outer ring, L-section ring and shaft locating washer have fixing holes.

The unit is located by means of retaining screws for transport and safe handling.

Sealing

Axial/radial bearings are supplied without seals.

Lubrication

The initial greasing of YRT and YRTS corresponds to the grease Arcanol LOAD150. The bearings can be lubricated via the outer ring and L-section ring.

Axial angular contact ball bearings

Axial angular contact ball bearings ZKLDF comprise a single-piece outer ring, a two-piece inner ring and two ball and cage assemblies with a contact angle of 60°. The outer ring and inner ring have fixing holes for screw mounting of the bearing on the adjacent construction.

The unit is located by means of retaining screws for transport and safe handling.

Sealing

Axial angular contact ball bearings have sealing shields on both sides.

Lubrication

The initial greasing of current axial angular contact ball bearings ZKLDF (Generation B) corresponds to the grease Arcanol MULTITOP. The bearings can be relubricated via the outer ring.

Operating temperature

Axial/radial bearings and axial angular contact ball bearings are suitable for operating temperatures from -30 °C to +120 °C.

Suffixes

Suffixes for available designs: see table.

Available designs

Suffix	Description	Design
H ₁ ...	For YRT, closer tolerance on mounting dimension H ₁ (postscript: H ₁ with tolerance ± ...) For restricted tolerance value, see table, page 31	Special design, available by agreement only
H ₂ ...	For YRT, closer tolerance on mounting dimension H ₂ (postscript: H ₂ with tolerance ± ...) For restricted tolerance value, see table, page 31	
–	For YRT, axial and radial runout tolerance restricted by 50% (additional text: axial/radial runout 50%) For YRTS, axial and radial runout tolerance of the rotating inner ring restricted by 50% (postscript: axial/radial runout of the inner ring 50%)	
VSP	For mounting with an axially supported L-section ring in series YRT, see page 27	

Design and safety guidelines

General safety guidelines

The general safety guidelines must be observed. Further information relating to safety of control circuits: see section Axial/radial bearings with angular measuring system.

Protection against accidental contact (EN 60529)



The guidelines on protection against accidental contact in accordance with EN 60529 must be observed.

After fitting, rotating components must be provided with adequate protection against accidental contact in operation.

Usage for the intended purpose

The products in this publication are suitable for use in chip-forming machine tools and in particular for the bearing arrangements of high precision rotary axes in milling and turning machines. Any usage outside the specified area or for purposes other than that intended is at the personal responsibility of the user.

Further information relating to bearings with angular measuring system: see page 65.

Modifications to the product

Modifications to the product are not permissible and will invalidate the warranty.

Machine safety under the terms of the Machinery Directive

The following rotary table bearings are, under the terms of the Machinery Directive 2006/42/EC, a component for integration in a complete system (finished or unfinished machine). The data and tests given in this publication relate purely to the components and are not a substitute for the detailed tests of the complete system.

Operating time

The operating time between two failures is described as the MTBF (Mean Time Between Failure). This can be calculated by agreement for rolling bearings and angular measuring devices. The operating time for rolling bearings is calculated on the basis of the load and speed duty cycle.

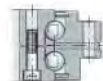

Axial/radial bearings

Axial angular contact ball bearings

Basic rating life

The load carrying capacity and life must be checked for the radial and axial bearing component.

Please contact us in relation to checking of the basic rating life. The speed, load and operating duration must be given.

Static load safety factor

The static load safety factor S_0 indicates the security against impermissible permanent deformations in the bearing:

$$S_0 = \frac{C_{0r}}{F_{0r}} \text{ or } \frac{C_{0a}}{F_{0a}}$$

S_0 – Static load safety factor
 C_{0r}, C_{0a} – Basic static load rating according to dimension tables
 F_{0r}, F_{0a} – Maximum static load on the radial or axial bearing.



In machine tools and similar areas of application, S_0 should be > 4 .

Static limiting load diagrams

The static limiting load diagrams can be used:

- for rapid checking of the selected bearing size under predominantly static load
- for calculation of the tilting moment M_k that can be supported by the bearing in addition to the axial load.

The limiting load diagrams are based on a rolling element set with a static load safety factor $S_0 \geq 4$, as well as the screw and bearing ring strength.



The static limiting load must not be exceeded when dimensioning the bearing, *Figure 2 to Figure 9*, page 13.

M_k = maximum tilting moment
 F_a = axial load

- ① Bearing, size
- ② Permissible range
- ③ Impermissible range

Figure 2
 Static limiting load diagram
 (example)

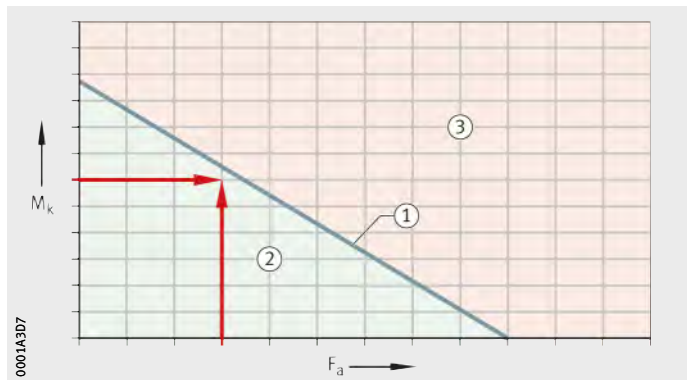

Axial/radial bearings

The static limiting load diagrams for YRT and YRTS are shown in *Figure 3 to Figure 7*, page 12.

M_k = maximum tilting moment
 F_a = axial load

Figure 3
 Static limiting load diagram
 for YRT50 to YRT200

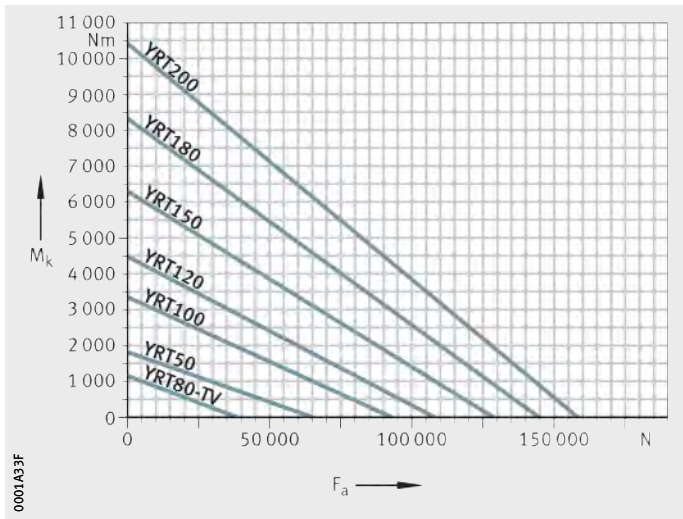

M_k = maximum tilting moment
 F_a = axial load

Figure 4
 Static limiting load diagram
 for YRT260 to YRT460

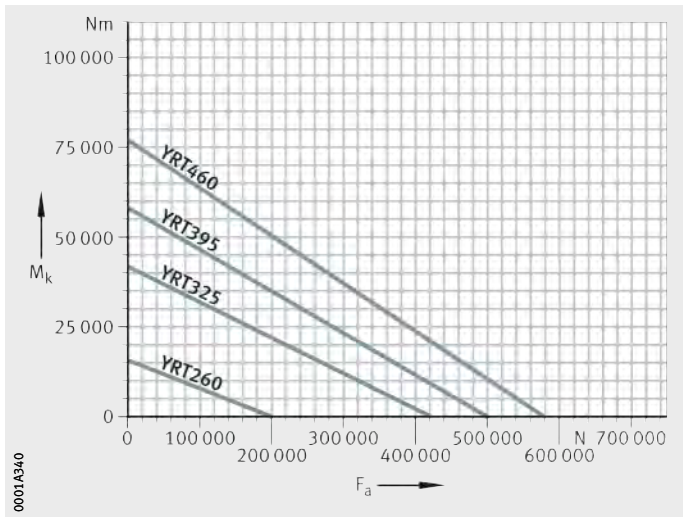

Axial/radial bearings

Axial angular contact ball bearings

M_k = maximum tilting moment
 F_a = axial load

Figure 5
 Static limiting load diagram
 for YRT580 to YRT850

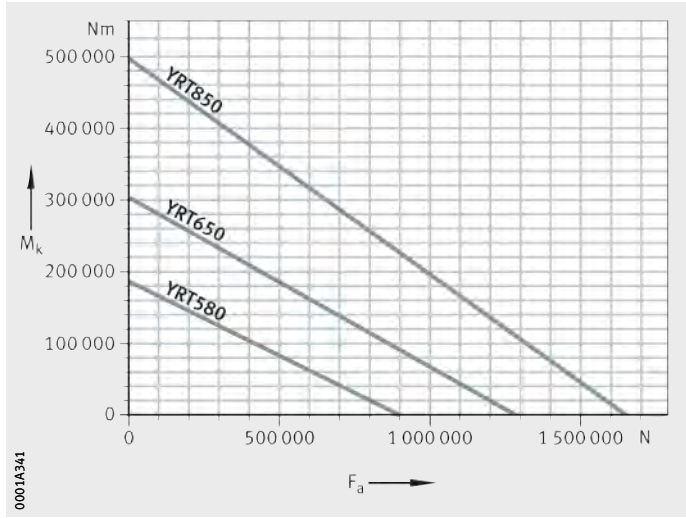

M_k = maximum tilting moment
 F_a = axial load

Figure 6
 Static limiting load diagram
 for YRT950 and YRT1030

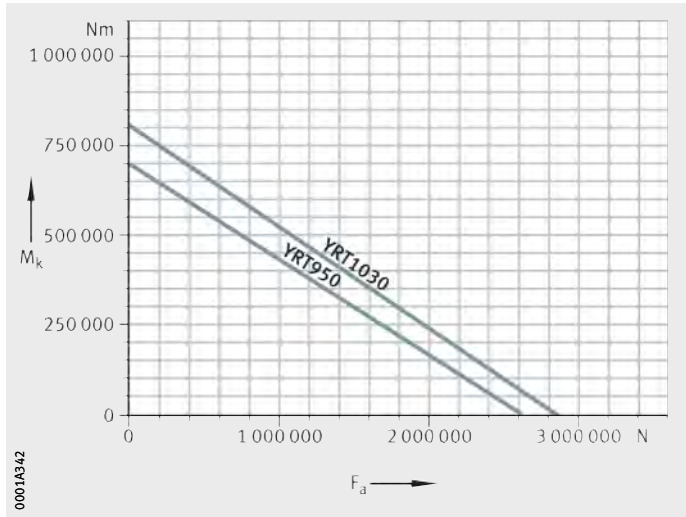

M_k = maximum tilting moment
 F_a = axial load

Figure 7
 Static limiting load diagram
 for YRTS200 to YRTS460

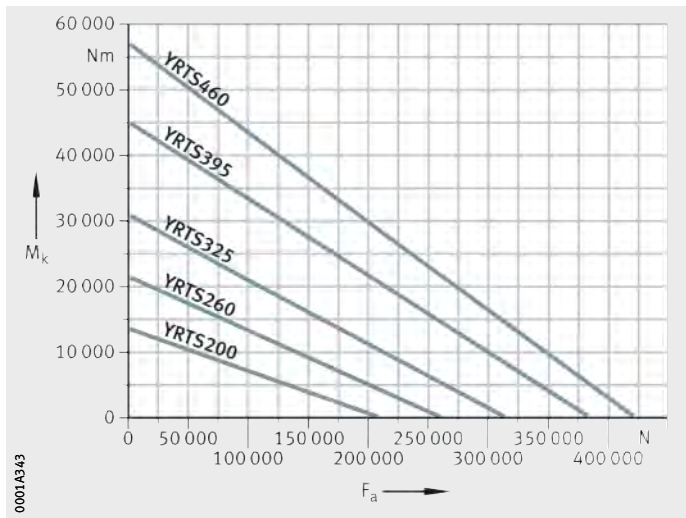

Axial angular contact ball bearings

The static limiting load diagrams for the series ZKLDF are shown in *Figure 8* and *Figure 9*.

M_k = maximum tilting moment
 F_a = axial load

Figure 8
 Static limiting load diagram for ZKLDF100 to ZKLDF200

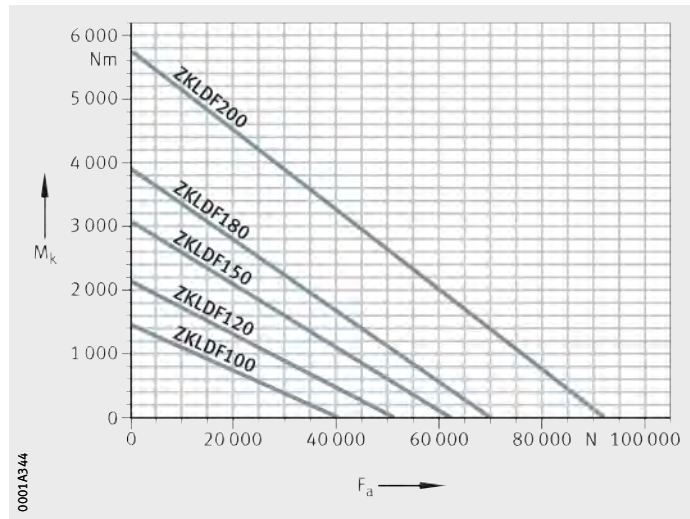

M_k = maximum tilting moment
 F_a = axial load

Figure 9
 Static limiting load diagram for ZKLDF260 to ZKLDF460

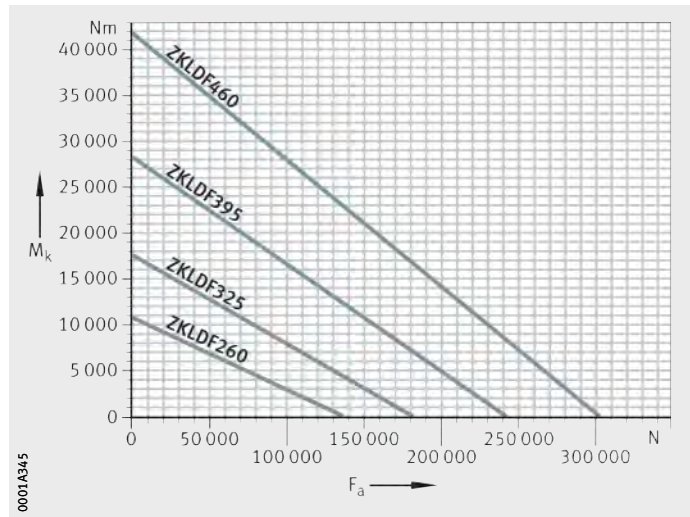

Axial/radial bearings

Axial angular contact ball bearings

Limiting speeds

In bearing selection, the following guidelines and the limiting speeds must be observed, see dimension tables.



If the environmental conditions differ from the specifications in relation to adjacent construction tolerances, lubrication, ambient temperature, heat dissipation or from the normal operating conditions for machine tools, the stated limiting speeds must be checked. Please contact us.

Axial/radial bearing YRT

Axial/radial bearings YRT are designed, by means of the full complement radial roller bearing component for high rigidity, for rapid positioning and operating at low speed. Low speeds are normally required for multiple-axis simultaneous machining. The limit value n_G stated in the dimension tables relates to the maximum swivel speed and a maximum speed applied for a short period.



In applications with a high operating duration ED or continuous operation at a speed of more than $n \times d = 35\,000 \text{ min}^{-1} \cdot \text{mm}$ at an ED > 10%, the series YRTS or ZKLDF should be selected.

Axial/radial bearings YRTS and axial angular contact ball bearings ZKLDF

The limiting speeds n_G stated for these two bearing series were determined on test rigs.

During the test, the following conditions apply:

- grease distribution cycle according to the defined data, see *Figure 14*
- maximum increase in bearing temperature of 40 K in the area of the raceway
- operating duration ED = 100%, which means continuous operation at the limiting speed n_G
- bearing fully screw mounted on solid fixtures
- no external load, only preload and mass of the fixtures.



The limiting speeds for the current ZKLDF (with effect from Generation B, internal suffix B) have been increased by a factor of two. With the introduction of the current bearings, the raceway system of axial angular contact ball bearings ZKLDF has been improved. Due to this improvement, it has been possible to halve the frictional torque of the bearing and double the limiting speeds while maintaining the high rigidity, load carrying capacity and accuracy.

Temperature distribution in the rotary axis system

Rotary axes with a main spindle function, such as those used for combined milling and turning and with direct drive by a torque motor, are systems with complex thermal characteristics.

The temperature distribution in the rotary axis system must be considered in greater detail during the design process:

- Asymmetrical rotary axis housings can undergo asymmetrical deformation due to heating.
- In turn, out-of-round bearing seats lead to additional bearing load, reduced life and a negative influence on running behaviour and running accuracy.
- Temperature management of the rotary axis in the form of targeted cooling and heating is generally necessary for high performance rotary axes. For simulation work, the Schaeffler Group has high performance simulation tools available.



Where there is non-uniform temperature distribution between the inner and outer ring, rotary axes with ball contact (ZKLDF) show more tolerant behaviour than rotary axis bearings with line contact (such as axial/radial cylindrical roller bearings or crossed roller bearings).



Axial/radial bearings

Axial angular contact ball bearings

Design regulations

Proven design regulations based on practical experiences, *Figure 10*:

- The contact face between the stator of the torque motor and the rotary table housing should be as small as possible, in order to minimise the flow of heat between stator and rotary table housing.
- Where possible, do not connect the casing of the stator cooling system to the rotary table housing.
- In preference, flange mount the rotor of the torque motor on the rotary table plate rather than on the bearing, to keep the flow of heat through the bearing to a minimum.
- The distance between the motor and the bearing should be as large as possible. A large distance reduces the transfer of heat from the rotor to the bearing. The stresses occurring between the components as a result of varying thermal expansion are reduced by the increased elasticity of the system.
- The rotary table plate bearing must be centered with sufficient rigidity to allow the overall system to attain a high level of rigidity. The risk of deformation to the bearing seat due to the increase in the temperature of the rotor is also reduced.
- Use torque motors which are suitable for the requirements only, with low loss of power and a high motor constant. We recommend using IDAM torque motors.



Regulated cooling of the stationary and rotating components may be required in order to limit the temperature variations between the bearing inner and outer ring.

\dot{Q} = heat flow
 x = distance from torque motor to bearing

- ① Stator of the torque motor
- ② Rotary table housing
- ③ Stator cooling
- ④ Rotor of the torque motor
- ⑤ Rotary table plate

Figure 10
Ideal rotary table,
taking account of the occurring heat

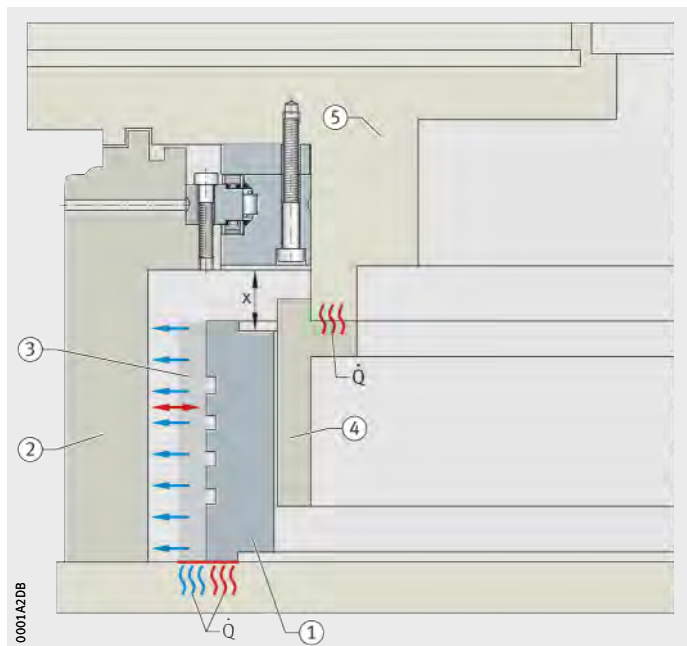

Bearing preload Once the bearings have been fitted and fully screw mounted, they are radially and axially clearance-free and preloaded.

Temperature differences Temperature differences between the shaft and housing influence the radial bearing preload and thus the operating life of the bearing arrangement.

If the shaft temperature is higher than the housing temperature, the radial preload will increase proportionally, so there will be an increase in the rolling element load, bearing friction and bearing temperature, while the operating life will be reduced.

If the shaft temperature is lower than the housing temperature, the radial preload will decrease proportionally, so the rigidity will decrease to bearing clearance. There will be an increase in wear, the operating life will be reduced and noise due to slippage may occur.



Frictional torque The bearing frictional torque M_{RL} is influenced primarily by the viscosity and quantity of the lubricant and the bearing preload:

- The lubricant viscosity is dependent on the lubricant grade and operating temperature.
- When relubrication is carried out, the lubricant quantity is increased for a short time until the grease is distributed and the excess quantity has left the bearing.
- During initial operation and after relubrication, bearing friction is increased until the lubricant has been distributed within the bearing.
- The bearing preload is dependent on the the mounting fits, the geometrical accuracy of the adjacent parts, the temperature difference between the inner and outer ring, the screw tightening torque and mounting situation (bearing inner ring axially supported on one or both sides).



Axial/radial bearings

Axial angular contact ball bearings

Guide values for frictional torque M_R

The stated frictional torques M_R are statistically determined guide values for bearings with grease lubrication after a grease distribution cycle, *Figure 14*, page 20. *Figure 11* shows measured frictional torque for mounting with an unsupported L-section ring for YRTS. In the mounting variant with an L-section ring supported over its washer thickness and the geometrical accuracy of the supporting ring by an average of 10% to 20%. The guide values for the frictional torque for axial/radial bearings YRT were determined at a measurement speed $n = 5 \text{ min}^{-1}$, see dimension table.



Deviations from the tightening torque of the fixing screws will have a detrimental effect on the preload and the frictional torque. For YRT bearings, it must be taken into consideration that the frictional torque can increase by a factor 2 to 2,5 with increasing speed.

M_R = frictional torque
n = speed

Figure 11
Frictional torques as guide values for YRTS, statistically determined values from series of measurements

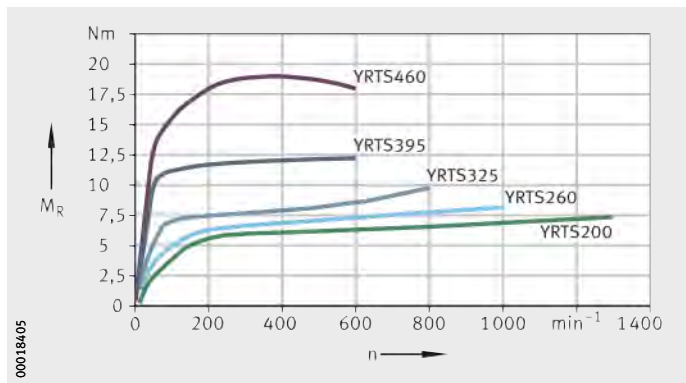

M_R = frictional torque
n = speed

Figure 12
Frictional torques as guide values for ZKLDF, statistically determined values from series of measurements

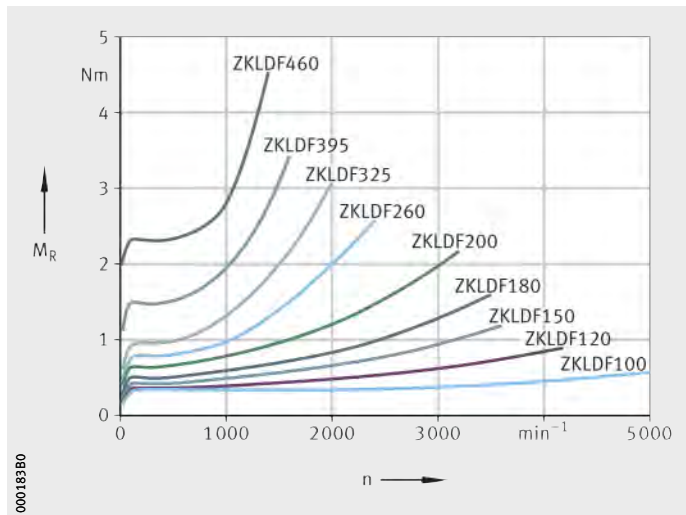

Relubrication and initial operation

The speed capability, friction, rating life, functional capability and the durations of relubrication intervals are essentially influenced by the grease used, see table.

Axial/radial bearings YRT and YRTS can be relubricated via a lubrication groove in the L-section ring and the outer ring.

Axial angular contact ball bearings ZKLDF can be relubricated via a lubrication groove in the outer ring.

The bearing series YRTS and ZKLDF, both of which are suitable for high speeds, now have (with effect from Generation B) an additional lubrication connector in the screw mounting face of the outer ring. This allows reliable feed of lubricant even where there is a large fit clearance in the bearing seat or the outer ring is free, *Figure 13*.

For calculation of the relubrication quantities and intervals based on a stated load spectrum (speed, load, operating duration) and the environmental conditions, please contact us.



Relubrication

Series	Relubrication using grease
YRT	Arcanol MULTITOP
YRTS	Arcanol LOAD150
ZKLDF..-B	Arcanol MULTITOP

- ① Relubrication via the lubrication groove in the outer ring
- ② Relubrication via the outer ring screw mounting face

Figure 13
Options for relubrication

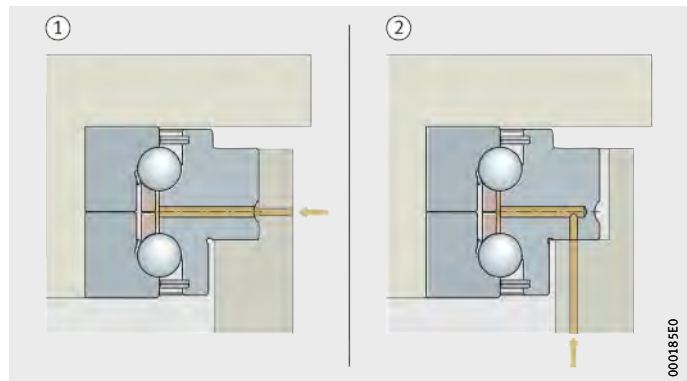

Axial/radial bearings

Axial angular contact ball bearings

Initial operation

Rolling bearings may exhibit increased frictional torque during initial operation, which can lead to overheating in the high speed series YRTS and ZKLDF where there is immediate operation at high speeds.



In order to prevent overheating of the bearing, the running-in cycle must always be carried out, *Figure 14*. The cycle may be shortened if there is appropriate monitoring of the bearing temperature. The bearing ring temperature must not exceed +60 °C.

Overlubrication

The two high speed bearing series YRTS and ZKLDF may be damaged by overheating as a result of increased frictional torque when operating at high speeds if they have been accidentally overlubricated.

In order to achieve the original frictional torque again, the running-in cycle in accordance with *Figure 14* should be carried out.

n_G = limiting speed
according to dimension tables
t = time

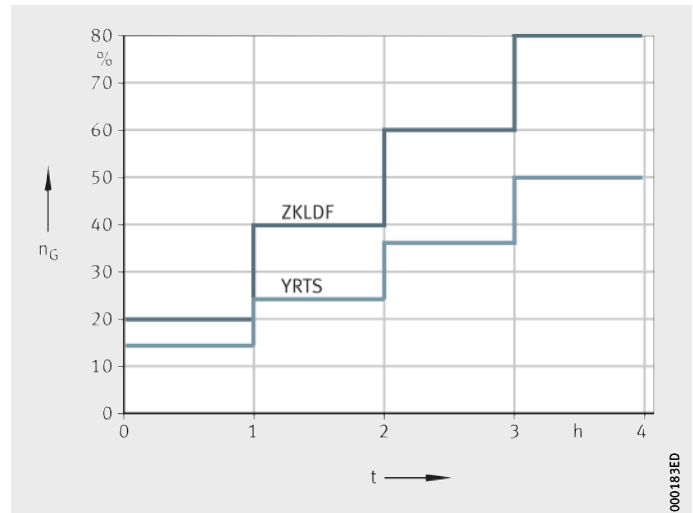

Figure 14
Running-in cycle for initial operation
and after overlubrication

Further information

- The further information on lubrication in Catalogue HR 1, chapter Lubrication must be observed.

Design of adjacent construction



YRT, YRTS and ZKLDF have almost the same mounting dimensions.

Geometrical defects in the screw mounting surfaces and fits will influence the running accuracy, preload and running characteristics of the bearing arrangement. The accuracy of the adjacent surfaces must therefore be matched to the overall accuracy requirement of the subassembly. The tolerances of the adjacent surfaces must lie within the running tolerance of the bearing.

The adjacent construction should be produced in accordance with *Figure 15* and the tolerances must be in accordance with the tables starting page 24. Any deviations will influence the bearing frictional torque, running accuracy and running characteristics.

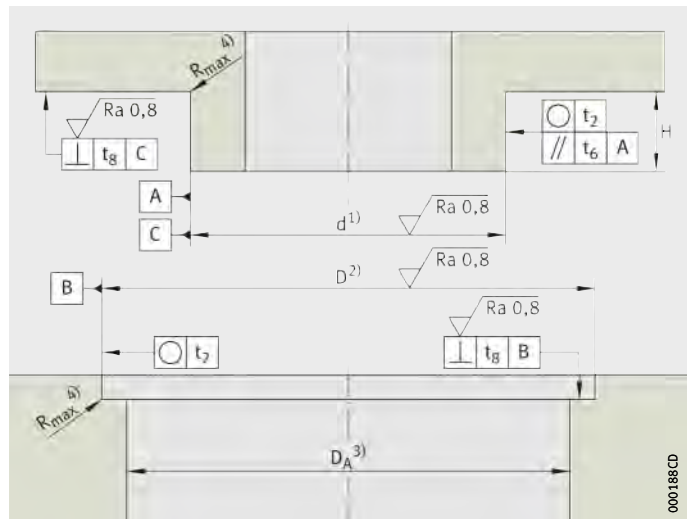

Figure 15
Requirements
for the adjacent construction,
YRT, YRTS, ZKLDF

Legend

- 1) Tolerance class: see tables, page 24 to page 25. Support over whole bearing height. It must be ensured that the means of support has adequate rigidity.
- 2) Tolerance class: see tables, page 24 to page 25. A precise fit is only necessary if radial support due to the load or a precise bearing position is required.
- 3) Note the bearing diameter D_1 in the dimension tables. Ensure that there is sufficient distance between the rotating bearing rings and the adjacent construction.
- 4) Values, see table Maximum corner radii of fit surfaces for YRT, YRTS, ZKLDF, page 25.

Axial/radial bearings

Axial angular contact ball bearings

Fits The selection of fits leads to transition fits, i.e. depending on the actual dimensional position of the bearing diameter and mounting dimensions, clearance fits or interference fits can arise.



The fit influences, for example, the running accuracy of the bearing and its dynamic characteristics.

An excessively tight fit will increase the radial bearing preload. As a result:

- there is an increase in bearing friction and heat generation in the bearing as well as the load on the raceway system and wear
- there will be a decrease in the achievable speed and the bearing operating life.

For easier matching of the adjacent construction to the actual bearing dimensions, each bearing of series YRT and YRTS is supplied with a measurement record (this is available by agreement for other series).

Axial and radial runout accuracy of the bearing arrangement

The axial and radial runout accuracy is influenced by:

- the running accuracy of the bearing
- the geometrical accuracy of the adjacent surfaces
- the fit between the rotating bearing ring and adjacent component.



For very high running accuracy, the rotating bearing ring should ideally have a fit clearance 0 and it should be ensured that the bearing has preload in operation, see page 17.

Recommended fits for shafts

The shaft should be produced to tolerance zone h5 and for series YRTS in accordance with table, page 25.

If there are special requirements, the fit clearance must be further restricted within the stated tolerance zones:

- Requirements for running accuracy:
Where maximum running accuracy is required and the bearing inner ring is rotating, the aim should be to achieve as close as possible to a fit clearance 0. The fit clearance may otherwise increase the bearing radial runout. With normal requirements for running accuracy or a stationary bearing inner ring, the shaft for axial/radial bearings YRT and ZKLDF should be produced to h5. For axial/radial bearing YRTS, the recommended fits for shaft and housing bore must be observed, see table, page 25.
- Requirements for dynamic characteristics:
 - For swivel operation ($n \times d < 35\,000 \text{ min}^{-1} \cdot \text{mm}$, operating duration $ED < 10\%$) the shaft should be produced to h5. The tolerance field h5 can be used under these operating conditions for axial/radial bearings YRT, ZKLDF and YRTS.
 - For higher speeds and longer operating duration, the fit interference must not exceed 0,01 mm. For series YRTS, the fit interference must not exceed 0,005 mm.

For series ZKLDF, the fit clearance should be based on the inner ring with the smallest bore dimension.

Recommended fits for housings

The housing should be produced to tolerance zone J6 and for series YRTS in accordance with table Recommended fits for shaft and housing bore for YRTS, page 25.

If there are special requirements, the fit clearance must be further restricted within the stated tolerance zones:

- Requirements for running accuracy:
For maximum running accuracy and with a rotating bearing outer ring, the aim should be to achieve as close as possible to a fit clearance of 0. With a static bearing outer ring, a clearance fit or a design without radial centring should be selected.
- Requirements for dynamic characteristics:
 - For predominantly swivel type operation ($n \times d < 35\,000 \text{ min}^{-1} \cdot \text{mm}$, operating duration ED < 10%) and a rotating bearing outer ring, the housing fit should be produced to tolerance zone J6. The tolerance field J6 can be used under these operating conditions for axial/radial bearings YRT, ZKLDF and YRTS.
 - For axial/radial bearing YRTS with a higher speed and operating duration, the bearing outer ring should not be radially centred or the housing fit should be produced as a clearance fit with at least 0,02 mm clearance. This will reduce the increase in preload that occurs where there is a temperature differential between the inner ring and outer ring of the bearing.



Fit selection depending on the screw connection of the bearing rings

If the bearing outer ring is screw mounted on the static component, a fit seating is not required or a fit seating can be produced as stated, see tables, page 24 to page 25. If the values in the table are used, this will give a transition fit with a tendency towards clearance fit. This generally allows easy fitting.

If the bearing inner ring is screw mounted on the static component, it should nevertheless for functional reasons be supported by the shaft over the whole bearing height. The shaft dimensions should then be selected accordingly, see tables, page 24 to page 25. If these values in the table are used, this will give a transition fit with a tendency towards clearance fit.

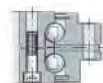

Axial/radial bearings

Axial angular contact ball bearings

Geometrical and positional accuracy of the adjacent construction



The values given in the following tables for geometrical and positional accuracy of the adjacent construction have proved effective in practice and are adequate for the majority of applications.

The geometrical tolerances influence the axial and radial runout accuracy of the subassembly as well as the bearing frictional torque and the running characteristics.

Diameter and geometrical tolerances for shafts for YRT and ZKLDF

Nominal shaft diameter		Deviation	Roundness Parallelism Perpendicularity
d mm		d	t ₂ , t ₆ , t ₈
over	incl.	for tolerance zone h5 μm	μm
50	80	0 -13	3
80	120	0 -15	4
120	180	0 -18	5
180	250	0 -20	7
250	315	0 -23	8
315	400	0 -25	9
400	500	0 -27	10
500	630	0 -32	11
630	800	0 -36	13
800	1 000	0 -40	15
1 000	1 250	0 -47	18

Diameter and geometrical tolerances for housings for YRT and ZKLDF

Nominal housing bore diameter		Deviation	Roundness Perpendicularity
D mm		D	t ₂ , t ₈
over	incl.	for tolerance zone J6 μm	μm
120	180	+18 -7	5
180	250	+22 -7	7
250	315	+25 -7	8
315	400	+29 -7	9
400	500	+33 -7	10
500	630	+34 -10	11
630	800	+38 -12	13
800	1 000	+44 -12	15
1 000	1 250	+52 -14	18

**Recommended fits
for shaft and housing bore
for YRTS**

Axial/radial bearing	Shaft diameter d mm	Housing bore D mm
YRTS200	200 ^{-0,01} _{-0,024}	300 ^{+0,011} _{-0,005}
YRTS260	260 ^{-0,013} _{-0,029}	385 ^{+0,013} _{-0,005}
YRTS325	325 ^{-0,018} _{-0,036}	450 ^{+0,015} _{-0,005}
YRTS395	395 ^{-0,018} _{-0,036}	525 ^{+0,017} _{-0,005}
YRTS460	460 ^{-0,018} _{-0,038}	600 ^{+0,017} _{-0,005}



**Geometrical and
positional accuracy
for shafts
for YRTS**

Axial/radial bearing	Roundness t ₂ μm	Parallelism t ₆ μm	Perpendicularity t ₈ μm
YRTS200	6	5	5
YRTS260 to YRTS460	8	5	7

**Geometrical and
positional accuracy
for housings
for YRTS**

Axial/radial bearing	Roundness t ₂ μm	Perpendicularity t ₈ μm
YRTS200 to YRTS460	6	8

**Maximum corner radii
of fit surfaces
for YRT, YRTS, ZKLDF**

Bore diameter d mm	Maximum corner radius R _{max} mm
50 incl. 150	0,1
over 150 incl. 460	0,3
over 460 incl. 950	1

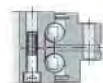

Axial/radial bearings

Axial angular contact ball bearings

Mounting dimensions H_1 , H_2



If the height variation must be as small as possible, the H_1 dimensional tolerance must conform to the tables, page 31 and page 32, and *Figure 16*.

The mounting dimension H_2 defines the position of any worm wheel used, *Figure 16* and *Figure 17*, page 27, L-section ring with support ring.

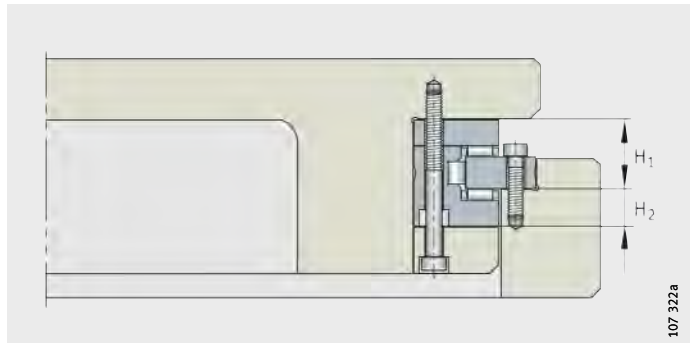

Figure 16
Mounting dimension H_1 , H_2

L-section ring without support ring or with support ring

The L-section ring of bearings YRT, YRTS and ZKLDF can be mounted unsupported or supported over its whole surface as an inner ring, *Figure 17*, page 27.

The support ring (for example a worm wheel or torque motor) is not included in the scope of delivery.

For series YRTS and ZKLDF, there is only one preload match.

The increase in rigidity and frictional torque in YRTS bearings is slight and can normally be ignored.

In bearings of series ZKLDF, the rigidity and frictional torque are not influenced by the support ring.

In fitting of the series YRT with an L-section ring supported axially over its whole surface, there is an increase in the axial rigidity in the direction of the support ring as a function of the support ring rigidity and in the tilting rigidity of up to 20%. In this case, delivery with a different preload match is necessary, suffix VSP.



If the normal design of series YRT (without suffix VSP) is mounted with a supported L-section ring, there will be a considerable increase in the bearing frictional torque.

The shaft locating washer must be supported axially over its whole surface by the adjacent construction. In the case of YRT.- VSP, the L-section ring must also be axially supported over its whole surface in order to achieve the stated rigidity values.

L-section ring without support ring

In the case of “L-section ring without support ring”, the bearing designation is:

■ YRT <bore diameter>.

L-section ring with support ring

For the case “L-section ring with support ring”, the bearing designation is:

■ YRT <bore diameter> **VSP**.



In the case of series YRT, the height of the support ring should be at least as large as the dimension H_2 of the bearing.

Any mounting conditions that deviate from our suggestions, *Figure 17*, may impair the function and the performance data of the bearings. For different designs, please contact us.

- YRT**
- ① Unsupported L-section ring

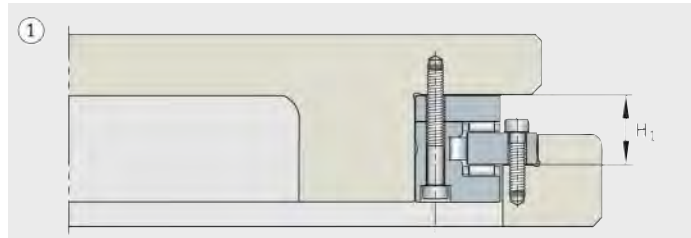

- YRT..VSP**
- ② Supported L-section ring

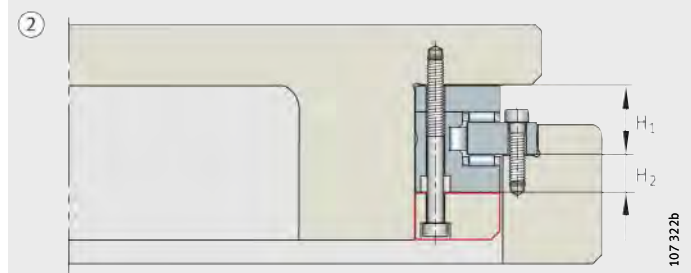

Figure 17
Mounting variants



Axial/radial bearings

Axial angular contact ball bearings

Improved ease of mounting

In order to ensure that the lubrication hole in the bearing is correctly positioned relative to the lubrication hole in the machine housing, the bearings YRTS and ZKLDF have a so-called pilot pin hole, see table and *Figure 18*.

Pilot pin hole

h mm max.	d_{STI} mm	d_{STB} mm min.
4	4	5

YRTS
ZKLDF

- ① Pilot pin hole for positioning of lubrication hole
 - ② Lubrication hole
- $t_1 = 0,5 \cdot t$

Figure 18
Improved ease of mounting
with axial lubrication hole

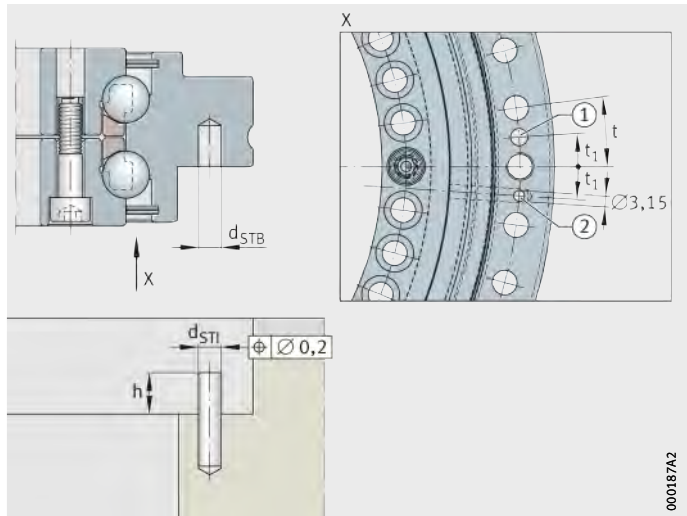

000187A2

Fitting Retaining screws secure the bearing components during transport. For easier centring of the bearing, the screws should be loosened before fitting and either secured again or removed after fitting.

Tighten the fixing screws in a crosswise sequence using a torque wrench in three stages to the specified tightening torque M_A , while rotating the bearing ZKLDF, *Figure 19*:

- Stage 1 40% of M_A
- Stage 2 70% of M_A
- Stage 3 100% of M_A .

Observe the correct grade of the fixing screws.



Mounting forces must only be applied to the bearing ring to be fitted, never through the rolling elements.

Bearing components must not be separated or interchanged during fitting and dismantling.

If the bearing is unusually difficult to move, loosen the fixing screws and tighten them again in steps in a crosswise sequence. This will eliminate any distortion.

Bearings should only be fitted in accordance with TPI 103, Fitting and Maintenance Manual.

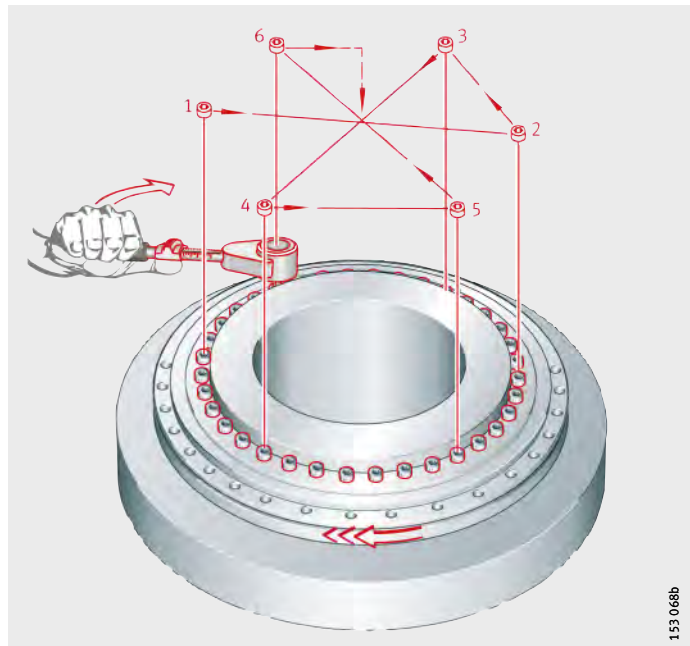

Figure 19
Tightening of fixing screws

Axial/radial bearings

Axial angular contact ball bearings

Static rigidity

The overall rigidity of a bearing position is a description of the magnitude of the displacement of the rotational axis from its ideal position under load. The static rigidity thus has a direct influence on the accuracy of the machining results.

The dimension tabs give the rigidity values for the complete bearing position, see page 34 to page 41. These take account of the deflection of the rolling element set as well as the deformation of the bearing rings and the screw connections.

The values for the rolling element sets are calculated rigidity values and are for information purposes only. They facilitate comparison with other bearing types, since rolling bearing catalogues generally only give the higher rigidity values for the rolling element set.

In the case of series YRT and YRTS, the axial rigidity in the corresponding direction and the tilting rigidity can be increased by supporting the L-section ring over its whole surface. The tilting rigidity is increased by up to 20% as a function of the thickness of the support washer.

Accuracy The dimensional tolerances are derived from tolerance class P5. The diameter tolerances stated are mean values in accordance with ISO 1132.

The geometrical tolerances correspond to P4 in accordance with DIN 620, see table.

The bearing bore in series YRT and YRTS may be slightly conical in the delivered condition. This is typical of the bearing design and is a result of the radial bearing preload forces. The bearing will regain its ideal geometry when fitted.

Dimensional tolerances and mounting dimensions for axial/radial bearing YRT

Dimensional tolerances ¹⁾				Mounting dimensions					
Bore		Outside diameter		Normal		Re-stricted ²⁾	Normal		Re-stricted ²⁾
d	Δ_{ds}	D	Δ_{Ds}	H ₁	Δ_{H1s}	Δ_{H1s}	H ₂	Δ_{H2s}	Δ_{H2s}
mm	mm	mm	mm	mm	mm	mm	mm	mm	mm
50	-0,008	126	-0,011	20	±0,025	-	10	±0,02	-
80	-0,009	146	-0,011	23,35	±0,025	-	11,65	±0,02	-
100	-0,01	185	-0,015	25	±0,025	-	13	±0,02	-
120	-0,01	210	-0,015	26	±0,025	-	14	±0,02	-
150	-0,013	240	-0,015	26	±0,03	-	14	±0,02	-
180	-0,013	280	-0,018	29	±0,03	-	14	±0,025	-
200	-0,015	300	-0,018	30	±0,03	-	15	±0,025	-
260	-0,018	385	-0,02	36,5	±0,04	-	18,5	±0,025	-
325	-0,023	450	-0,023	40	±0,05	-	20	±0,025	-
395	-0,023	525	-0,028	42,5	±0,05	-	22,5	±0,025	-
460	-0,023	600	-0,028	46	±0,06	-	24	±0,03	-
580	-0,025	750	-0,035	60	±0,25	±0,075	30	±0,25	±0,03
650	-0,038	870	-0,05	78	±0,25	±0,1	44	±0,25	±0,03
850	-0,05	1 095	-0,063	80,5	±0,3	±0,12	43,5	±0,3	±0,03
950	-0,05	1 200	-0,063	86	±0,3	±0,12	46	±0,3	±0,03
1 030	-0,063	1 300	-0,08	92,5	±0,3	±0,15	52,5	±0,3	±0,03

1) The diameter tolerances stated are mean values (DIN 620).

2) Special design with suffix, see table, page 8.

Dimensional tolerances and mounting dimensions for axial/radial bearing YRTS

Dimensional tolerances ¹⁾				Mounting dimensions		
Bore		Outside diameter		H ₁	Δ_{H1s}	H ₂
d	Δ_{ds}	D	Δ_{Ds}	mm	mm	mm
mm	mm	mm	mm			
200	-0,015	300	-0,018	30	+0,04 -0,06	15
260	-0,018	385	-0,02	36,5	+0,05 -0,07	18,5
325	-0,023	450	-0,023	40	+0,06 -0,07	20
395	-0,023	525	-0,028	42,5	+0,06 -0,07	22,5
460	-0,023	600	-0,028	46	+0,07 -0,08	24

1) The diameter tolerances stated are mean values (DIN 620).

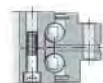

Axial/radial bearings

Axial angular contact ball bearings

Dimensional tolerances and mounting dimensions for axial/radial bearing ZKLDF

Dimensional tolerances ¹⁾				Mounting dimensions	
Bore		Outside diameter		H ₁ mm	Δ _{H1s} mm
d mm	Δ _{ds} mm	D mm	Δ _{Ds} mm		
100	-0,01	185	-0,015	25	±0,175
120	-0,01	210	-0,015	26	±0,175
150	-0,013	240	-0,015	26	±0,175
180	-0,013	280	-0,018	29	±0,175
200	-0,015	300	-0,018	30	±0,175
260	-0,018	385	-0,02	36,5	±0,2
325	-0,023	450	-0,023	40	±0,2
395	-0,023	525	-0,028	42,5	±0,2
460	-0,023	600	-0,028	46	±0,225

1) The diameter tolerances stated are mean values (DIN 620).

Axial and radial runout for axial/radial bearings YRT, YRTS and ZKLDF

Bore d mm	Axial and radial runout ¹⁾ t ₁				
	YRT		YRTS		ZKLDF
	Normal ²⁾	Restricted ²⁾	Normal ²⁾	Restricted ³⁾	Normal ²⁾
	μm		μm		μm
50	2	1	–	–	–
80	3	1,5	–	–	–
100	3	1,5	–	–	3
120	3	1,5	–	–	3
150	3	1,5	–	–	3
180	4	2	–	–	4
200	4	2	4	2	4
260	6	3	6	3	6
325	6	3	6	3	6
395	6	3	6	3	6
460	6	3	6	3	6
580	10	5 ⁴⁾	–	–	–
650	10	5 ⁴⁾	–	–	–
850	12	6 ⁴⁾	–	–	–
950	12	6 ⁴⁾	–	–	–
1 030	12	6 ⁴⁾	–	–	–

1) Measured on fitted bearing with ideal adjacent construction.

2) For rotating inner and outer ring.

3) For rotating inner ring only.

4) Available by agreement.

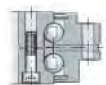
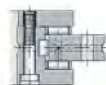

Axial/radial bearings

Double direction

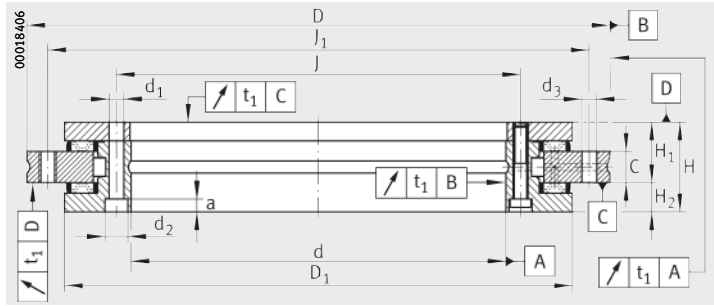

YRT

Dimension table - Dimensions in mm

Designation	Mass m ≈ kg	Dimensions										Fixing holes					
		d	D	H	H ₁	H ₂	C	D ₁	J	J ₁	Inner ring				Outer ring		
											d ₁	d ₂	a	Quantity ⁴⁾	d ₃	Quantity ⁴⁾	
YRT50	1,6	50	126	30	20	10	10	105	63	116	5,6	–	–	10	5,6	12	
YRT80-TV⁵⁾⁷⁾	2,4	80	146	35	23,35	11,65	12	130	92	138	5,6	10	4	10	4,6	12	
YRT100⁵⁾	4,1	100	185	38	25	13	12	161	112	170	5,6	10	5,4	16	5,6	15	
YRT120	5,3	120	210	40	26	14	12	185	135	195	7	11	6,2	22	7	21	
YRT150	6,2	150	240	40	26	14	12	214	165	225	7	11	6,2	34	7	33	
YRT180	7,7	180	280	43	29	14	15	244	194	260	7	11	6,2	46	7	45	
YRT200	9,7	200	300	45	30	15	15	274	215	285	7	11	6,2	46	7	45	
YRT260	18,3	260	385	55	36,5	18,5	18	345	280	365	9,3	15	8,2	34	9,3	33	

- 1) Including retaining screws or threaded extraction holes.
- 2) Tightening torque for screws to DIN 912, grade 10.9.
- 3) Rigidity values taking account of the rolling element set, the deformation of the bearing rings and the screw connections. For explanations, see page 30.
- 4) Attention! For fixing holes in the adjacent construction. Observe the pitch of the bearing holes.
- 5) Screw counterbores in the L-section ring open to the bearing bore. The bearing inside diameter is unsupported in the area ②.
- 6) For high operating durations or continuous operation, please contact us.
- 7) Cages made from glass fibre reinforced polyamide 66.
- 8) Measurement speed $n_{const} = 5 \text{ min}^{-1}$.

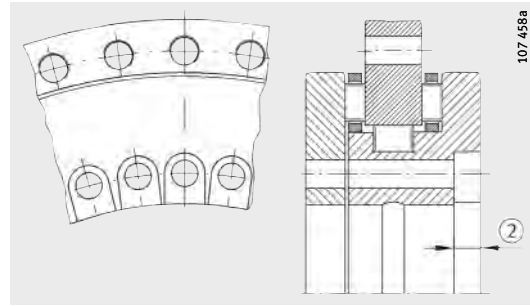
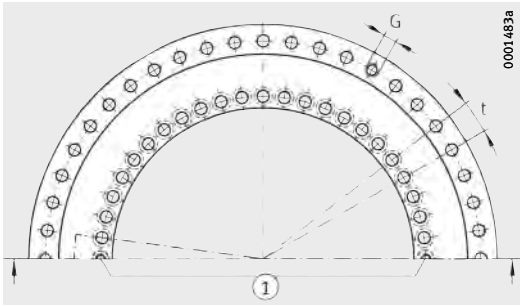

Hole pattern

① Two retaining screws

For YRT80-TV and YRT100:

② Screw counterbores open⁵⁾

Pitch $t^1)$ QuantityXt	Threaded extraction hole		Screw tightening torque $M_A^{2)}$ Nm	Basic load ratings				Limiting speed ⁶⁾ n_G min^{-1}	Bearing frictional torque ⁸⁾ M_R Nm
	G	Quantity		axial		radial			
				dyn. C_a N	stat. C_{0a} N	dyn. C_r N	stat. C_{0r} N		
12X30°	–	–	8,5	56 000	280 000	28 500	49 500	440	2,5
12X30°	–	–	8,5/4,5	38 000	158 000	44 000	98 000	350	3
18X20°	M5	3	8,5	73 000	370 000	52 000	108 000	280	3
24X15°	M8	3	14	80 000	445 000	70 000	148 000	230	7
36X10°	M8	3	14	85 000	510 000	77 000	179 000	210	13
48X7,5°	M8	3	14	92 000	580 000	83 000	209 000	190	14
48X7,5°	M8	3	14	98 000	650 000	89 000	236 000	170	15
36X10°	M12	3	34	109 000	810 000	102 000	310 000	130	25



Designation	Rigidity					
	of bearing position ³⁾			of rolling element set		
	axial c_{aL} $\text{kN}/\mu\text{m}$	radial c_{rL} $\text{kN}/\mu\text{m}$	Tilting rigidity c_{kL} kNm/mrad	axial c_{aL} $\text{kN}/\mu\text{m}$	radial c_{rL} $\text{kN}/\mu\text{m}$	Tilting rigidity c_{kL} kNm/mrad
YRT50	1,3	1,1	1,25	6,2	1,5	5,9
YRT80-TV⁵⁾⁷⁾	1,6	1,8	2,5	4	2,6	6,3
YRT100⁵⁾	2	2	5	6,8	2,4	15
YRT120	2,1	2,2	7	7,8	3,8	24
YRT150	2,3	2,6	11	8,7	4,6	38
YRT180	2,6	3	17	9,9	5,3	57
YRT200	3	3,5	23	11,2	6,2	80
YRT260	3,5	4,5	45	13,7	8,1	155

Axial/radial bearings

Double direction

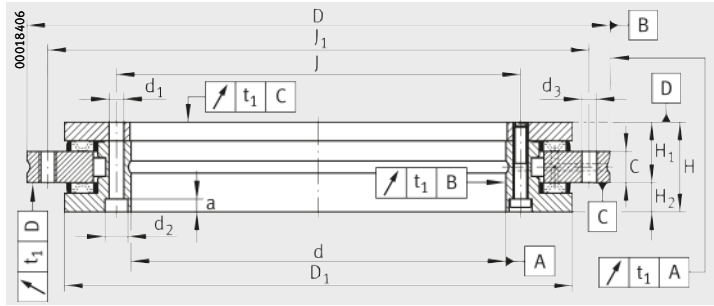

YRT

Dimension table (continued) · Dimensions in mm

Designation	Mass m ≈ kg	Dimensions										Fixing holes					
		d	D	H	H ₁	H ₂	C	D ₁ max.	J	J ₁	Inner ring				Outer ring		
											d ₁	d ₂	a	Quantity ⁴⁾	d ₃	Quantity ⁴⁾	
YRT325 ⁵⁾	25	325	450	60	40	20	20	415	342	430	9,3	15	8,2	34	9,3	33	
YRT395	33	395	525	65	42,5	22,5	20	486	415	505	9,3	15	8,2	46	9,3	45	
YRT460	45	460	600	70	46	24	22	560	482	580	9,3	15	8,2	46	9,3	45	
YRT580	89	580	750	90	60	30	30	700	610	720	11,4	18	11	46	11,4	42	
YRT650	170	650	870	122	78	44	34	800	680	830	14	20	13	46	14	42	
YRT850	253	850	1095	124	80,5	43,5	37	1018	890	1055	18	26	17	58	18	54	
YRT950 ⁷⁾	312	950	1200	132	86	46	40	1130	990	1160	18	26	17	58	18	54	
YRT1030	375	1030	1300	145	92,5	–	40	1215	1075	1255	18	26	17	70	18	66	

Dimensions d > 1030 mm available by agreement.

- 1) Including retaining screws or threaded extraction holes.
- 2) Tightening torque for screws to DIN 912, grade 10.9.
- 3) Rigidity values taking account of the rolling element set, the deformation of the bearing rings and the screw connections. For explanations, see page 30.
- 4) Attention!
For fixing holes in the adjacent construction. Observe the pitch of the bearing holes.
- 5) Screw counterbores in the L-section ring open to the bearing bore. The bearing inside diameter is unsupported in the area ②.
- 6) For high operating durations or continuous operation, please contact us.
- 7) Not to be used for new designs, available by agreement only.
- 8) Measurement speed $n_{const} = 5 \text{ min}^{-1}$.

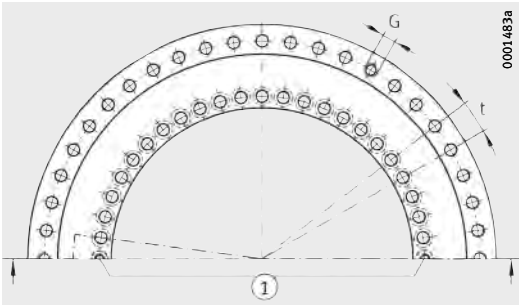

Hole pattern

① Two retaining screws

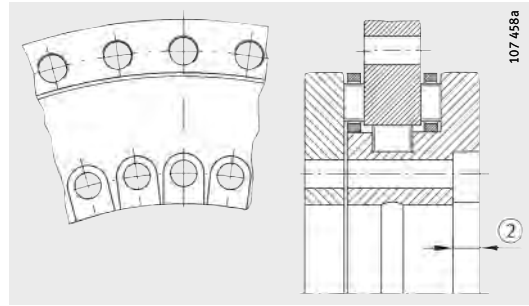

For YRT325:

② Screw counterbores open⁵⁾

Pitch t ¹⁾	Threaded extraction hole		Screw tightening torque M _A ²⁾ Nm	Basic load ratings				Limiting speed ⁶⁾ n _G min ⁻¹	Bearing frictional torque ⁸⁾ M _R Nm	
	QuantityXt	G		Quantity	axial		radial			
					dyn. C _a N	stat. C _{0a} N	dyn. C _r N			stat. C _{0r} N
36X10°	M12	3	34	186 000	1 710 000	134 000	415 000	110	48	
48X7,5°	M12	3	34	202 000	2 010 000	133 000	435 000	90	55	
48X7,5°	M12	3	34	217 000	2 300 000	187 000	650 000	80	70	
48X7,5°	M12	6	68	390 000	3 600 000	211 000	820 000	60	140	
48X7,5°	M12	6	116	495 000	5 200 000	415 000	1 500 000	55	200	
60X6°	M16	6	284	560 000	6 600 000	475 000	1 970 000	40	300	
60X6°	M16	6	284	1 040 000	10 300 000	600 000	2 450 000	40	600	
72X5°	M16	6	284	1 080 000	11 000 000	620 000	2 650 000	35	800	



Designation	Rigidity					
	of bearing position ³⁾			of rolling element set		
	axial c _{aL} kN/μm	radial c _{rL} kN/μm	Tilting rigidity c _{kL} kNm/mrad	axial c _{aL} kN/μm	radial c _{rL} kN/μm	Tilting rigidity c _{kL} kNm/mrad
YRT325⁵⁾	4,3	5	80	26,1	9,4	422
YRT395	4,9	6	130	30,3	11,3	684
YRT460	5,7	7	200	33,5	13,9	1 049
YRT580	6,9	9	380	42,1	17,4	2 062
YRT650	7,6	10	550	58,3	13,7	3 669
YRT850	9,3	13	1 100	73,4	20,2	7 587
YRT950 ⁷⁾	10,4	14	1 500	74,5	16,4	9 692
YRT1030	11,2	16	1 900	79,7	18,8	12 025

Axial/radial bearings

Double direction

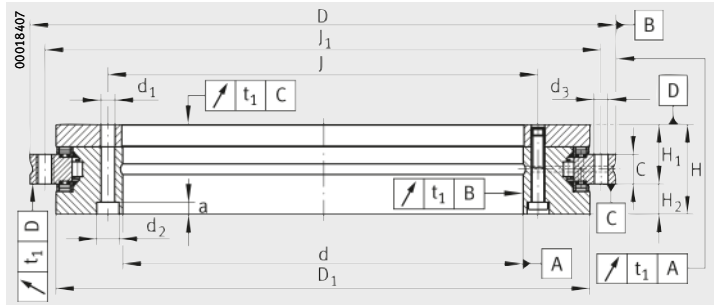

YRTS

Dimension table - Dimensions in mm

Designation	Mass m ≈kg	Dimensions									Fixing holes					
		d	D	H	H ₁	H ₂	C	D ₁	J	J ₁	Inner ring				Outer ring	
											d ₁	d ₂	a	Quantity ³⁾	d ₃	Quantity ³⁾
YRTS200	9,7	200	300	45	30	15	15	274	215	285	7	11	6,2	46	7	45
YRTS260	18,3	260	385	55	36,5	18,5	18	345	280	365	9,3	15	8,2	34	9,3	33
YRTS325⁵⁾	25	325	450	60	40	20	20	415	342	430	9,3	15	8,2 ⁵⁾	34	9,3	33
YRTS395	33	395	525	65	42,5	22,5	20	486	415	505	9,3	15	8,2	46	9,3	45
YRTS460	45	460	600	70	46	24	22	560	482	580	9,3	15	8,2	46	9,3	45

- 1) Including retaining screws or threaded extraction holes.
- 2) For screws to DIN 912, grade 10.9.
- 3) Attention!
For fixing holes in the adjacent construction.
Observe the pitch of the bearing holes.
- 4) Rigidity values taking account of the rolling element set,
the deformation of the bearing rings and the screw connections.
For explanations, see page 30.
- 5) Screw counterbores in the L-section ring open to the bearing bore.
The bearing inside diameter is unsupported in the area ②.

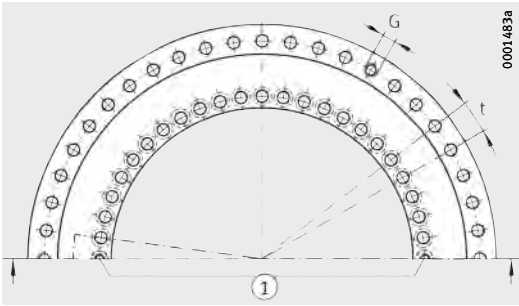

Hole pattern
① Two retaining screws

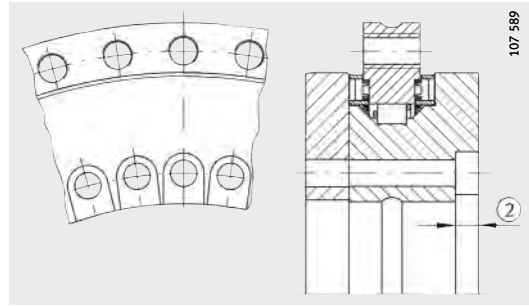

For YRTS325:
② Screw counterbores open⁵⁾

Pitch $t^1)$	Threaded extraction hole		Screw tightening torque $M_A^{2)}$ Nm	Basic load ratings				Limiting speed n_G min ⁻¹	Mass moment of inertia for rotating	
	G	Quantity		axial		radial			Inner ring IR M_M kg · cm ²	Outer ring AU kg · cm ²
				dyn. C_a N	stat. C_{0a} N	dyn. C_r N	stat. C_{0r} N			
48X7,5°	M8	3	14	155 000	840 000	94 000	226 000	1 160	667	435
36X10°	M12	3	34	173 000	1 050 000	110 000	305 000	910	2 074	1 422
36X10°	M12	3	34	191 000	1 260 000	109 000	320 000	760	4 506	2 489
48X7,5°	M12	3	34	214 000	1 540 000	121 000	390 000	650	8 352	4 254
48X7,5°	M12	3	34	221 000	1 690 000	168 000	570 000	560	15 738	7 379



Designation	Rigidity					
	of bearing position ⁴⁾			of rolling element set		
	axial c_{aL} kN/μm	radial c_{rL} kN/μm	Tilting rigidity c_{kL} kNm/mrad	axial c_{aL} kN/μm	radial c_{rL} kN/μm	Tilting rigidity c_{kL} kNm/mrad
YRTS200	4	1,2	29	13,6	3,9	101
YRTS260	5,4	1,6	67	16,8	5,8	201
YRTS325⁵⁾	6,6	1,8	115	19,9	7,1	350
YRTS395	7,8	2	195	23,4	8,7	582
YRTS460	8,9	1,8	280	25,4	9,5	843

Axial angular contact ball bearings

Double direction

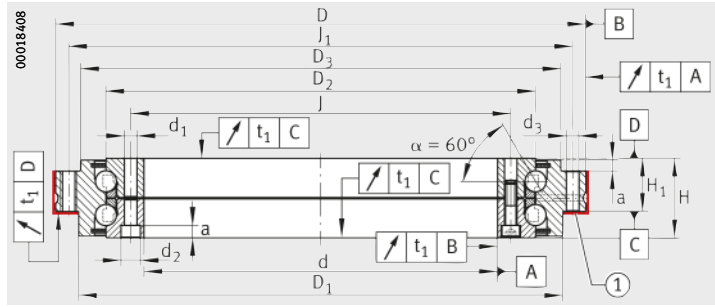

ZKLDF

① Contact surface/centring diameter

Dimension table - Dimensions in mm

Designation	Mass m ≈kg	Dimensions										Inner ring		
		d	D	H	H ₁	D ₁	D ₂	D ₃	J	J ₁	a	Fixing screws		
												d ₁	d ₂	Quantity ⁴⁾
ZKLDF100 ⁵⁾	3,8	100	185	38	25	161	136	158	112	170	5,4	5,6	10	16
ZKLDF120	4,8	120	210	40	26	185	159	181	135	195	6,2	7	11	22
ZKLDF150	5,6	150	240	40	26	214	188	211	165	225	6,2	7	11	34
ZKLDF180	7,7	180	280	43	29	244	219	246	194	260	6,2	7	11	46
ZKLDF200	10	200	300	45	30	274	243	271	215	285	6,2	7	11	46
ZKLDF260	19	260	385	55	36,5	345	313	348	280	365	8,2	9,3	15	34
ZKLDF325 ⁵⁾	25	325	450	60	40	415	380	413	342	430	8,2	9,3	15	34
ZKLDF395	33	395	525	65	42,5	486	450	488	415	505	8,2	9,3	15	46
ZKLDF460	47	460	600	70	46	560	520	563	482	580	8,2	9,3	15	46

Dimensions d > 460 mm available by agreement.

- 1) Including retaining screws or threaded extraction holes.
- 2) Tightening torque for screws to DIN 912, grade 10.9.
- 3) Rigidity values taking account of the rolling element set, the deformation of the bearing rings and the screw connections. For explanations, see page 30.
- 4) Attention!
For fixing holes in the adjacent construction. Note the pitch of the bearing holes.
- 5) Screw counterbores in the L-section ring open to the bearing bore. The bearing inside diameter is unsupported in the area ③.
- 6) The limiting speeds increased by a factor of two are valid for bearings of the current generation with the internal suffix -B.

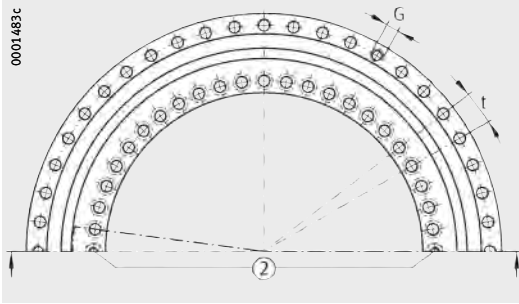

Hole pattern
② Two retaining screws

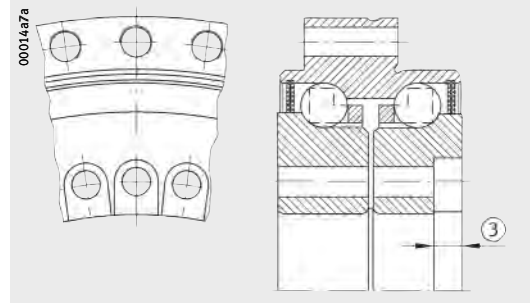

For ZKLDF100, ZKLDF325:
③ Screw counterbores open⁵⁾

Outer ring				Pitch $t^1)$	Screw tightening torque	Basic load ratings		Limiting speed ⁶⁾
Fixing screws		Threaded extraction hole				axial		
d_3	Quantity ⁴⁾	G	Quantity	QuantityXt	$M_A^2)$ Nm	dyn. C_a N	stat. C_{0a} N	n_G min ⁻¹
5,6	15	M5	3	18X20°	8,5	71 000	265 000	5 000
7	21	M8	3	24X15°	14	76 000	315 000	4 300
7	33	M8	3	36X10°	14	81 000	380 000	3 600
7	45	M8	3	48X7,5°	14	85 000	440 000	3 500
7	45	M8	3	48X7,5°	14	121 000	610 000	3 200
9,3	33	M12	3	36X10°	34	162 000	920 000	2 400
9,3	33	M12	3	36X10°	34	172 000	1 110 000	2 000
9,3	45	M12	3	48X7,5°	34	241 000	1 580 000	1 600
9,3	45	M12	3	48X7,5°	34	255 000	1 860 000	1 400



Designation	Rigidity					
	of bearing position ³⁾			of rolling element set		
	axial c_{aL} kN/ μ m	radial c_{rL} kN/ μ m	Tilting rigidity c_{kL} kNm/mrad	axial c_{aL} kN/ μ m	radial c_{rL} kN/ μ m	Tilting rigidity c_{kL} kNm/mrad
ZKLDF100 ⁵⁾	1,2	0,35	3,6	2,2	0,35	5
ZKLDF120	1,5	0,4	5,5	2,5	0,4	8
ZKLDF150	1,7	0,4	7,8	2,9	0,4	12
ZKLDF180	1,9	0,5	10,7	2,8	0,5	16
ZKLDF200	2,5	0,6	17,5	3,7	0,6	26
ZKLDF260	3,2	0,7	40	4,7	0,7	54
ZKLDF325 ⁵⁾	4	0,8	60	5,4	0,8	90
ZKLDF395	4,5	0,9	100	6,3	0,9	148
ZKLDF460	5,3	1,1	175	7,1	1,1	223



FAG

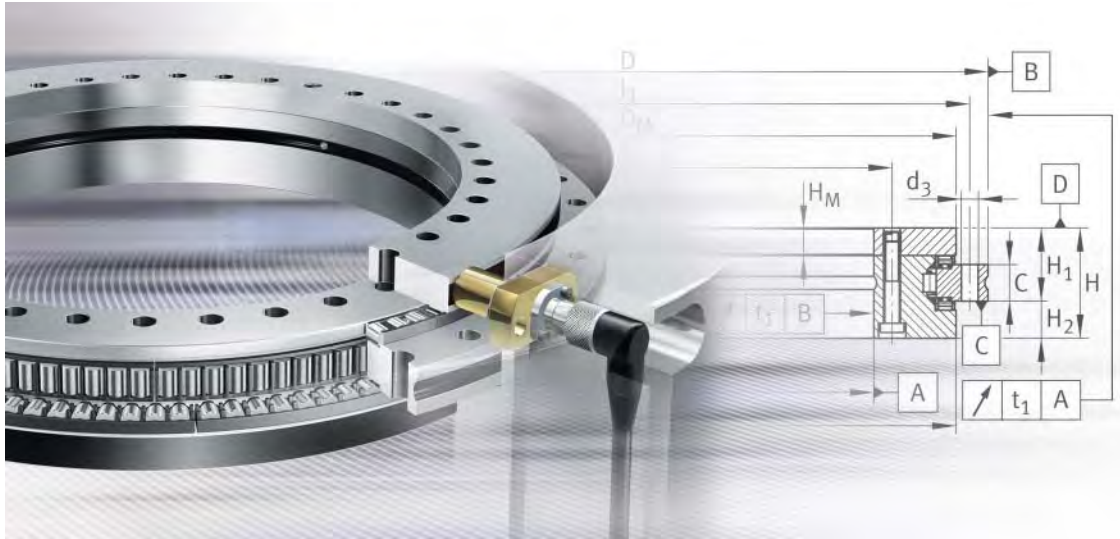

**Axial/radial bearings
with angular measuring system**

Axial/radial bearings with angular measuring system

	Page
Product overview	Axial/radial bearings with angular measuring system 44
Features	Advantages of the angular measuring system 45
	Dimensional scale 46
	Measuring heads with magneto-resistive sensors..... 47
	Electronic evaluation system 47
	Cables for signal transmission 48
	Setting and diagnosis program 50
	Measurement accuracy..... 51
	Error-free signal transmission 53
	Measures to protect against interference 54
	Laying of signal cables..... 56
	Compatibility..... 57
	Test according to standard..... 58
	Technical data 60
	Detection of zero position, functional principle 62
	Special design..... 62
Design and safety guidelines	Design of adjacent construction 63
	Safety-related information about the measuring device under the terms of the Machinery Directive 65
	Fitting..... 66
Ordering example, ordering designation	Unit..... 68
	Also required..... 69
	Replacement parts..... 69
Dimension tables	Axial/radial bearings, double direction, with measuring system 70
	SRM electronic measuring system 74



Product overview

Axial/radial bearings with angular measuring system

Axial/radial bearings
With magnetic dimensional scale

YRTM, YRTSM

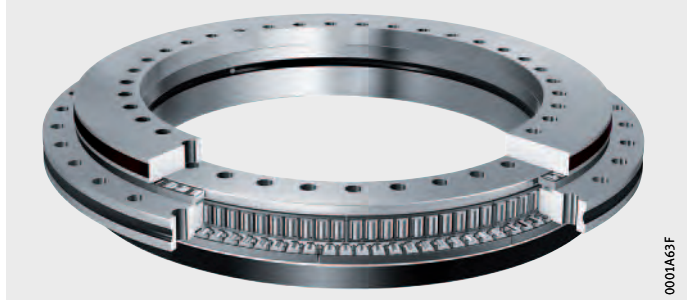

Electronic measuring system
Measuring heads with shims

SRM

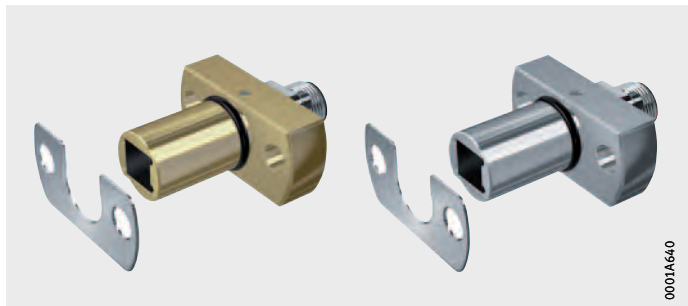

Electronic evaluation system

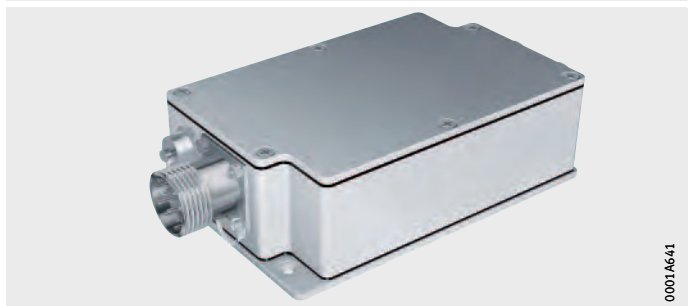

Connection cable
For measuring heads and electronic measuring system

SRMC

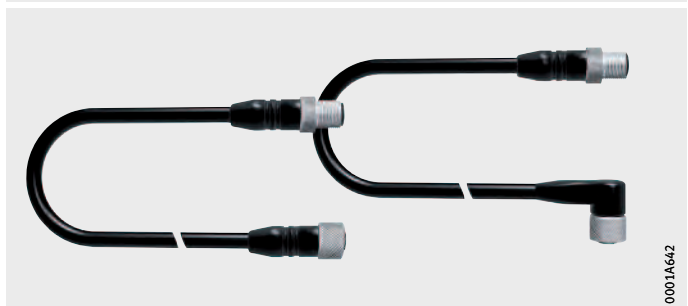

Axial/radial bearings with angular measuring system

Features

Axial/radial bearings with angular measuring system comprise:

- an axial/radial bearing YRTM or YRTSM with a dimensional scale, an SRM electronic measuring system and signal leads SRMC. The electronic measuring system SRM comprises two measuring heads, two stacks of shims and an electronic evaluation system. The signal leads for connecting the measuring heads to the electronic evaluation system can be ordered individually in various designs. The electronic measuring system MEKO/U will continue to be available but should no longer be used for new designs.

Bearings of series YRTM or YRTSM correspond in mechanical terms to axial/radial bearings YRT or YRTS but are additionally fitted with a magnetic dimensional scale. The measuring system can measure angles to an accuracy of a few angular seconds by non-contact, magneto-resistive means.

For the mechanical part of axial/radial bearings YRTM or YRTSM, please refer to the information from page 7 to page 32.

Advantages of the angular measuring system

The measuring system, *Figure 1*, page 46:

- allows, due to the rigid connection to the adjacent construction, very good control characteristics (control stability and dynamics) and is therefore particularly suitable for axes with torque motor drive
- offers a high maximum speed of up to 16,5 m/s
- operates by non-contact means and is therefore not subject to wear
- carries out measurement irrespective of tilting and position
- has automatically self-adjusting electronics
- has a self-centring function
- is unaffected by lubricants
- is easy to fit, the measuring heads are easily adjustable, there is no need for alignment of the bearing and a separate measuring system
- requires no additional parts
 - the dimensional scale and measuring heads are integrated in the bearing and adjacent construction respectively
 - the resulting space saved can be used for the machining area of the machine
- does not give any problems relating to supply cables. The cables can be laid within the adjacent construction directly through the large bearing bore
- gives savings on design envelope size and costs due to the compact, integrated design requiring fewer components.



Axial/radial bearings with angular measuring system

- ① Magnetic scale
- ② Magnetic field lines
- ③ Measuring head with magneto-resistive sensor
- ④ Electronic evaluation system
- ⑤ Analogue signals at output

Figure 1
Measurement principle

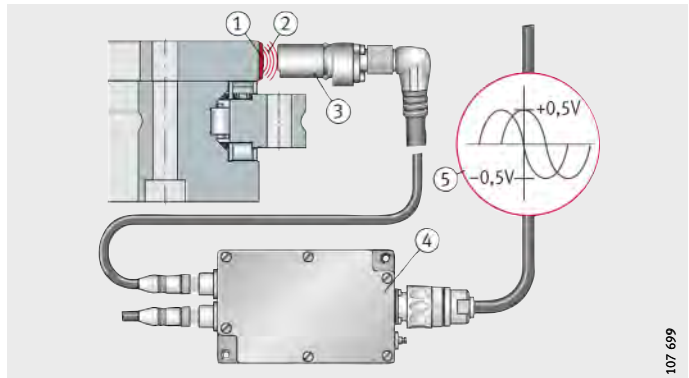

Dimensional scale

The dimensional scale is applied without seams or joins to the outside diameter of the shaft locating washer. The magnetically hard coating has magnetic poles at a pitch of $250\ \mu\text{m}$ that serve as angle references, *Figure 2*.

The angular position is measured incrementally, i.e. by counting the individual increments. For a fixed datum point for the angular position after the machine is switched on, an additional reference mark is therefore also required.

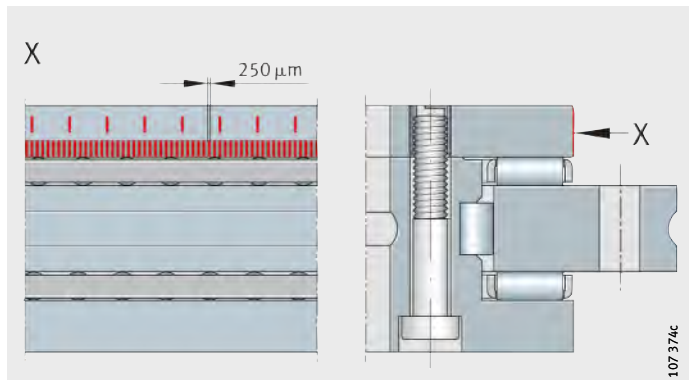

Figure 2
Dimensional scale

Reference marks

The system has pitch-coded reference marks in order to quickly create the absolute datum point. Every 15° , reference marks are applied with defined different pitches, so that the absolute datum point is achieved by passing over two adjacent reference marks (maximum 30°).

Measuring heads with magneto-resistive sensors

The measuring heads are colour coded:

- the silver measuring head (white) scans the incremental track
- the gold measuring head (yellow) scans the incremental track and the reference marks.

The two measuring heads are designed for optimum use of space. They are fixed in a slot in the adjacent construction by means of two fixing screws.

MR effect

The small magnetic fields are detected as a result of the magneto-resistive effect (MR effect). Compared with magnetic heads, the MR sensors allow static measurement of magnetic fields, i. e. electrical signals are derived without movement, in contrast to magnetic heads.

The resistance layer of the MR sensors is designed such that the resistance changes when a magnetic field is perpendicular to the current flow.

When the magnetic pitch moves past the MR sensor, two sine wave signals with a phase offset of 90° are generated with a period length of $500\ \mu\text{m}$.

O-rings for sealing

The measuring heads have O-rings to seal against the egress of oil and the ingress of fluids such as cooling lubricants.

Electronic evaluation system

The electronic evaluation system operates with the aid of a digital signal processor (DSP).

The input signals are digitised by an analogue/digital converter. The high performance processor (DSP) automatically compares the sensor signals and calculates the effective angular value from the sensor signals by means of vector addition. Correction is carried out, for example, on the offset of the analogue signals. A digital/analogue converter generates synthetic analogue signals as a $1\ V_{SS}$ value.

The electronic evaluation system can be positioned at any location or within the adjacent construction. It is connected to the controller by means of a conventional 12-pin extension cable.

The lead for transmitting the voltage signals from the electronic evaluation system to the electronic post-processor can be up to 100 m long.



Axial/radial bearings with angular measuring system

Cables for signal transmission

The signal cables for connecting the measuring heads to the electronic evaluation system are available in the lengths 1 m, 2 m and 3 m, see table, page 49.

The connection side for the electronic evaluation system has a straight plug. The connection side to the measuring head is suitable for straight plugs or 90° elbow plugs.

In the case of the elbow plug, the cable outlet direction is defined in relation to the mounting position of the measuring heads.

Advantages

The cables are suitable for use in machinery and plant for chip-forming machining:

- the cables and plugs are shielded
- the cable sheathing is made from polyurethane (PUR), halogen-free and flame-resistant
- the signal cables are free from halogens, silicones and PVC as well as resistant to microbes and hydrolysis
- the cables are resistant to oils, greases and cooling lubricants, see TPI 154, Integral angular measuring system
- the cables are suitable for dynamic use in flexible trunking (it must be ensured that they are laid correctly).

Bending cycles

When laid in flexible trunking, the cables can achieve ≥ 2 million bending cycles under the following test conditions:

- bending radius 65 mm ($10 \times D$)
- acceleration 5 m/s^2
- travel speed 200 m/min
- travel distance 5 m, horizontally.

Plug connectors

INA plug connectors are robust and designed for use in industrial environments. When connected, they conform to protection grade IP 65 (EN 60 529).

The large sheathed areas of the plugs ensure effective shielding.

Connection cables

Measuring heads are connected using cables with 90° elbow plugs or cables with straight plugs, *Figure 3*.

- ① 90° elbow plug (SRMC...-A)
- ② Straight plug (SRMC...-S)

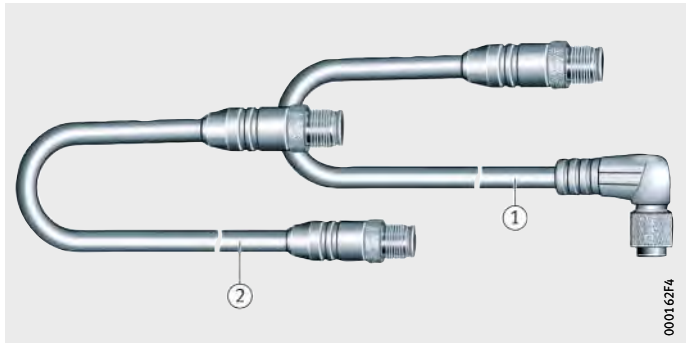

Figure 3
Connection cable

Design and length of connection cable, see table.

Designs

Plug design	Cable length m	Ordering designation
Straight plugs on both ends	1	SRMC1-S
	2	SRMC2-S
	3	SRMC3-S
Straight plug and 90° elbow plug	1	SRMC1-A
	2	SRMC2-A
	3	SRMC3-A

Other designs available by agreement.

Dimensions of plugs and measuring heads, see page 75.



Use cables of the same length for connecting the two measuring heads in a measuring system.



Axial/radial bearings with angular measuring system

Setting and diagnosis program

The distance between the measuring heads and the outside diameter of the shaft locating washer is set using the setting and diagnosis software MEKOEDS, *Figure 12*, page 67 and see MON 18, Axial/radial bearings with angular measuring system.

The software is also used to check the function of the fitted measuring system and detect defects in the measuring system.

MEKOEDS is supplied on a USB memory stick, *Figure 4*. The USB memory stick also contains the appropriate manuals, see page 69. The current version of MEKOEDS and the manuals is available at www.schaeffler.com.

Interface cable

The measuring system is connected to a PC (serial interface) using the interface cable, *Figure 4*.

The interface cable is included in the delivery of MEKOEDS, the length is 5 m. If the PC does not have a serial interface, we recommend the use of a conventional serial/USB converter, which is not included in the delivery.

- ① USB memory stick
- ② Interface cable

Figure 4
MEKOEDS

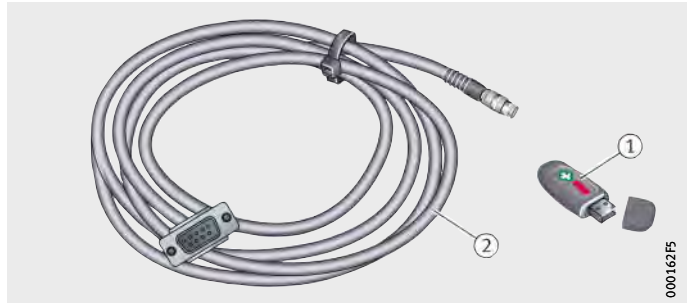

The measuring system data can be recorded, displayed in diagram form, printed out and sent by e-mail to the Schaeffler Group for evaluation.

Measurement accuracy

The more accurate the angular measurement, the more accurately a rotary axis can be positioned. The accuracy of angular measurement is essentially determined by:

- ① the quality of the dimensional scale
- ② the quality of scanning
- ③ the quality of the electronic evaluation system
- ④ the eccentricity of the dimensional scale to the bearing raceway system
- ⑤ the runout deviation of the bearing arrangement
- ⑥ the elasticity of the measurement system shaft and its linkage to the shaft to be measured
- ⑦ the elasticity of the stator shaft and shaft coupling.

For the measuring system integrated in the bearing, only points ① to ③ are relevant.

The eccentricity in point ④ is completely eliminated by the diametrically opposed arrangement of the MR sensors.

Points ⑤ to ⑦ play only a very minor role in the INA measuring system.

Positional deviations

Positional deviations within a revolution are the absolute measurement errors over one revolution of the system (measured at +20 °C ambient temperature):

- YRTM150 $\leq \pm 6''$
- YRTM180 $\leq \pm 5''$
- YRT(S)M200, YRT(S)M260, YRT(S)M325, YRT(S)M395, YRT(S)M460 $\leq \pm 3''$.

Since the dimensional scale is directly connected, i. e. without any compensation elements, with the rolling bearing, deflections in the bearing raceway system due to machining forces could affect the measurement result. This effect is eliminated by the diametrically opposed arrangement of the measuring heads in the electronic evaluation system.



Axial/radial bearings with angular measuring system

Measurement record

Each INA measuring system is supplied with an accuracy measurement record, *Figure 5*.

The accuracy is measured on the coded washer of the YRTM or YRTSM bearing when the coding is applied and is documented.

The measurement trace shows the pitch error of the coding.

- ① Measurement travel in degrees
- ② Deviation in angular seconds

Figure 5
Excerpt from a measurement trace,
example:
YRTM 395 – S.Nr. 03/09/004

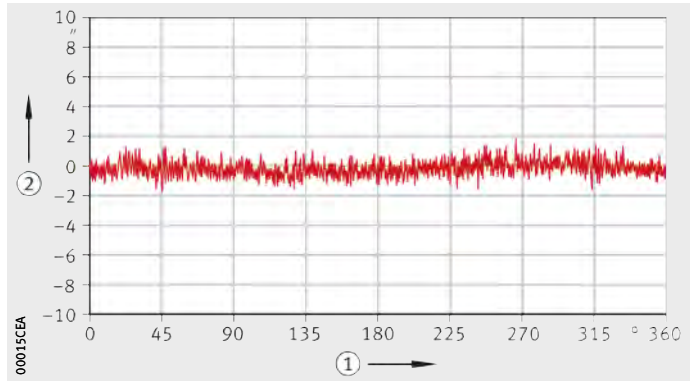

Error-free signal transmission

If the INA measuring system is fitted and operated as specified, it fulfils the requirements of Directives 89/336/EEC and 92/031/EEC for electromagnetic compatibility (EMC).

Adherence to the EMC directive in accordance with the following standards is demonstrated:

- EN 61000-6-2 Immunity
 - ESD:
EN 61000-4-2
 - radiated electromagnetic fields:
EN 61000-4-3
 - burst:
EN 61000-4-4
 - surge:
EN 61000-4-5
 - conducted immunity:
EN 61000-4-6
 - magnetic field:
EN 61000-4-8
- EN 55 011-B Emission
 - interference voltage:
EN 55 011-B
 - perturbing radiation:
EN 55 011-B.

Possible sources of electrical interference in the transmission of measurement signals

Disruptive voltage is mainly generated and transmitted by capacitive or inductive interference. Interference can occur through lines and equipment inputs and outputs.

Sources of interference include:

- strong magnetic fields due to transformers and electric motors
- relays, contactors and solenoid valves
- high frequency equipment, pulse devices and magnetic stray fields due to switched-mode power supply units
- supply mains and leads to the equipment mentioned above.



Interference in initial operation can generally be attributed to absent or inadequate shielding of the measurement leads or insufficient spacing between the signal and power cables.

The overall design should be such that the function of the measuring system is not influenced by sources of electrical or mechanical interference.



Axial/radial bearings with angular measuring system

Measures to protect against interference



The precision bearing and measuring system must be handled with care.

The dimensional scale and sensor surface of the measuring heads are unprotected once the protective covers have been removed.

Screw the electronic evaluation system firmly to the earthed machine frame, *Figure 6*. If screw mounting surfaces are non-conductive, one of the fixing screws should be connected by electrically conductive means over the largest possible cross-section and a short route with the machine frame; all measuring system components must have the same potential.

The bearing components must be connected by electrically conductive means with equipotential bonding.

For signal connections, only shielded plug connectors and cables should be used.

- ① Electronic evaluation system
- ② Shielded plug connectors and cable
- ③ Adjacent construction
- ④ CNC (electronic post-processing system)

Figure 6
Shielding and post-processor

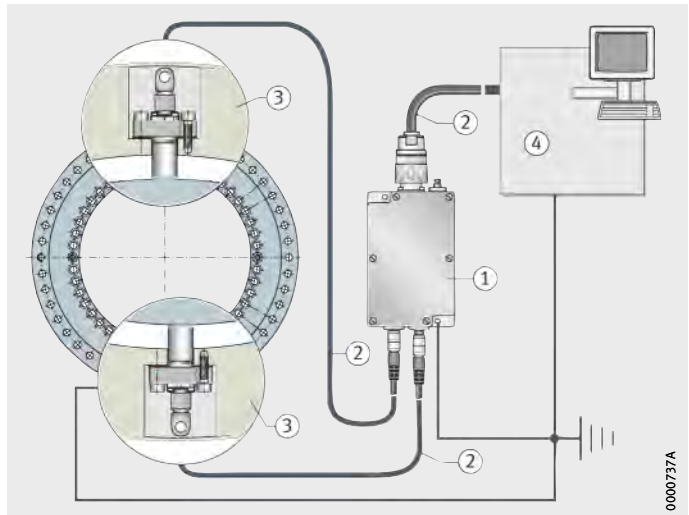

0000737A

Protection against magnetic fields



Magnetic fields will damage or erase the dimensional scale. This will lead in some cases to mismeasurement by the system.

Magnetic sources must be kept away from the magnetic scale on the outside diameter of the shaft locating washer. A field strength of approx. 70 mT or higher immediately on the coding carries the risk of damage to the magnetic increments.

Magnetic dial gauge stands must not be placed directly on the coded washer; the guide value is at least 100 mm distance in air or 10 mm unalloyed steel, *Figure 7* and *Figure 8*.

Never touch the coding with magnetisable objects.

Typical examples are knives, screwdrivers and dial gauge feelers.

Prevent contact with magnetisable contaminants. These could otherwise be deposited on the coding and lead to impaired measurement accuracy.

This could be due to:

- contamination of the lubricant, for example due to the oil bath
- contamination washed off by condensation, e.g. in conjunction with cooling devices
- wear debris from gears.

① Minimum distance > 100 mm

Figure 7
Minimum distance between magnetic dial gauge stand and shaft locating washer

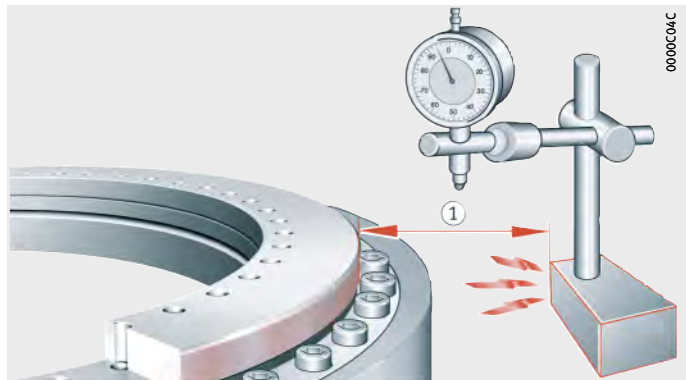

① Shielding > 10 mm

Figure 8
Shielding by unalloyed steel

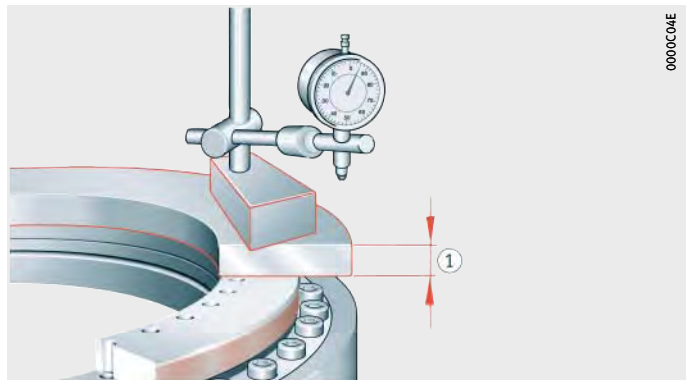

Axial/radial bearings with angular measuring system

Pressing down
the measuring head by hand



In order to protect the sensor chip against damage, the measuring head can only be pressed against the dimensional scale by hand. Forces > 50 N can lead to sensor damage.

Laying of signal cables

Laying of disruptive and suppressed or non-disruptive cables in parallel and in spatial vicinity should be avoided. Separation in air of > 100 mm is recommended. If adequate spacing cannot be achieved, additional shielding or earthed metallic partition walls between the cables should be provided.

The requirement for spatial separation of cables also applies to typical sources of interference such as servo drives, frequency converters, contactors, solenoid valves and choking coils.

Crossings

If cables must be crossed, this should be carried out at a 90° angle if possible.

Overlong cables

Overlong cables that are located rolled up in the switch cabinet will act as antennae and cause unnecessary interference. These cables should be cut to the required length.

Shielding

If shield separations are necessary, these should be reconnected over as large an area as possible. The free lead ends to the connector terminal should be as short as possible. Shield separations are a functional risk and should therefore be avoided.

Ends not required

Non-assigned ends should be connected on both sides with reference potential (chassis ground).

Motor connectors

No other cables for data cabling should be fed within shielded motor cables or terminal boxes for motor connectors. Spatial separation is also recommended here, for example by sheet metal partitions.

Interference suppression filter

Connections between interference suppression filters and the emission source should be kept as short as possible and should be shielded.

Compatibility The analogue output signals 1 V_{SS} of the incremental track can be processed by all conventional CNC controllers.

For new applications, it should be checked whether the CNC controller can be parametrised in accordance with the technical data of the YRTM or YRTSM.

For most controllers, the input parameters can be requested from us.

Input of pulse rate On many controllers, the pulse rate can be directly inputted. Pulse rate, see table, page 60. In isolated cases, however, this is carried out via a whole number multiplication and division value.

In these cases, the pulse rate cannot be entered exactly for sizes YRTM200 or YRTSM200 and YRTM395 or YRTSM395 and must be corrected using other parameters.

Pitch-coded reference marks Some controllers cannot record signals from pitch-coded measuring systems. For these cases, the electronic measuring system can be supplied as a single reference mark measuring system. Please state this in the order text.

The differential pitch between two adjacent reference marks is two signal periods. In the zero transition area, the system design of the encoder leads to a large difference. The controller must be capable of processing this aspect.



In swivel type axes, the measuring system zero point (marked on the bearing using a drill bit) can be placed outside the scanning range of the yellow measuring head.

With continuous monitoring of the pitch-coded reference marks, the limiting speed n_G for the reference travel must not be exceeded, see dimension table.



Axial/radial bearings with angular measuring system

Test according to standard	The functional capability has been tested under changing climatic conditions, under mechanical load and in contact with water, oil and cooling lubricants.	
Climatic tests	The measuring system design has been tested in accordance with the following standards.	
Cold	According to standard	IEC 68-2-1
	Storage temperature	-10 °C, ±3 °C
	Dwell time	72 hours
Dry heat	According to standard	IEC 68-2-2
	Storage temperature	+70 °C, ±2 °C
	Dwell time	72 hours
Thermal cycling	According to standard	IEC 68-2-14
	Lower storage temperature	-20 °C, ±3 °C
	Upper storage temperature	+60 °C, ±3 °C
	Change gradient	1 °C/min
	Dwell time	3 hours at each limit temperature
	Number of cycles	5
Thermal shock	According to standard	IEC 68-2-14
	Lower storage temperature	-5 °C, ±3 °C
	Upper storage temperature	+55 °C, ±3 °C
	Change duration	≤ 8 sec
	Dwell time	20 min at each limit temperature
	Number of cycles	10
Humid heat, cyclic	According to standard	IEC 68-2-30
	Lower storage temperature	+25 °C, ±3 °C
	Upper storage temperature	+55 °C, ±3 °C
	Change duration	3 hours to 6 hours
	Cycle duration	24 hours
	Number of cycles	6

Mechanical tests	The measuring system design has been tested in accordance with the following standards.	
	DIN EN 60086-2-6 MIL-STD-202, 204 C	Condition B
Vibration, sine wave (measuring heads)	According to standard	IEC 68-2-6
	Frequency range	10 Hz to 2 kHz
	Vibration amplitude	±0,76 mm (10 Hz to 60 Hz) 100 m/s ² (60 Hz to 2 kHz)
	Rate	1 octave/min
	Load duration	240 min per axis
	Number of frequency cycles	16 per axis
	Load directions	All three main axes
Shocks (measuring heads)	According to standard	IEC 68-2-27
	Acceleration	30 g
	Shock duration	18 m/s
	Shock type	Semisine wave
	Number of shock cycles	6 per axis
	Load directions	All three main axes (i. e. a total of 18 cycles)
IP protection type, protection against ingress of water	The measuring system design has been tested in accordance with the following standards.	
	According to standard	DIN 40050-9
	Protection type	IP67
	Ingress protection testing is carried out with water as a medium and over a limited time period. All push-fit connections are fitted. The measuring system should therefore be fitted with protection against cooling lubricants.	
Chemical resistance (measuring heads)	The measuring system design has been tested in accordance with the following standards.	
Resistance to oils	Test media	Mineral oil Aral Degol BG150 PAO Mobilgear SHC XMP150 Ester Shell Omala EPB150 PG Klüber Klübersynth GH6-150
	Storage temperature	+60 °C
	Storage duration	168 hours
Resistance to cooling lubricants (KSS)	Test media	Unitech Hosmac SL145 ZG Zubora 92F MR Oemeta Hycut ET46 Unitech Hosmac S558
	Storage temperature	+35 °C
	Storage duration	168 hours
	Concentration	5% in water
	For different operating conditions, please contact us.	



Axial/radial bearings with angular measuring system

Technical data

Technical data on the SRM electronic measuring system, see table.

SRM electronic measuring system

Data	Specification	Comments
Power supply	DC +5 V ±10%	–
Current consumption	280 mA	Box with measuring heads YE, WH
Scale	Magnetically hard electroplated coating with periodic North-South pitch	–
Incremental signals Pulse rate/accuracy (at +20 °C)	1 V _{SS} YRTM150: 2 688/±6" YRTM180: 3 072/±5" YRTM200, YRTSM200: 3 408/±3" YRTM260, YRTSM260: 4 320/±3" YRTM325, YRTSM325: 5 184/±3" YRTM395, YRTSM395: 6 096/±3" YRTM460, YRTSM460: 7 008/±3"	–
Reference marks	24, pitch approx. 15°, pitch-coded	–
Fixed reference mark pitch	30°	–
Differential pitch between two reference marks	2 signal periods	–
Data interface	RS232C	–
Recommended measurement step	0,0001°	–
Operating temperature	from 0 °C to +70 °C	–
Ingress protection (EN 60 529)	IP67 (all plugs fitted)	–
Masses: ■ Measuring heads ■ Electronic evaluation system	each approx. 38 g 450 g	–
Electrical connections: ■ Measuring heads ■ Electronic post-processing system (not included in scope of delivery)	with: PUR cable Ø 6,5 mm with: plug Ø 15 mm with: 12 pin flanged plug, Ø 28 mm	–
Permissible cable length for electronic post-processor	max. 100 m	–
Humidity	max. 70% relative humidity, non-condensing	–
Output signal load	100 Ω to 120 Ω	Recommended CNC input resistance

SRM electronic measuring system
continued

Data	Specification	Comments
Output signal ①, ②	0,9 V _{SS} typically, 0,8 V to 1 V maximal	120 Ω load resistance, f = 100 Hz
Signal difference ①, ②	< 1% typically	Difference in output signal amplitude between signal ①, ②, f = 100 Hz
Output constant voltage	2,4 V ± 10%	Output signals ① +, ① -, ② +, ② -
Output offset voltage ①, ②	± 10 mV typically, ± 50 mV max.	Constant current offset between ① + and ① -, ② + and ② -
Reference signal Z ③	Width: 230° typically, 180° to 270° max. Centre position, see <i>Figure 9</i>	From output signal period ①, ② at recommended reference movement speed
Reference signal mean voltage	2,4 V ± 10%	–
Reference signal level	0,8 V _{SS} typically, 0,6 V to 1 V maximal Inactive: -0,4 V Active: +0,4 V	120 Ω load resistance
Output frequency ①, ②	DC up to 8 kHz max.	–
System resolution	max. 2 500 steps per sine wave	–



Axial/radial bearings with angular measuring system

Detection of zero position, functional principle

The CNC checks whether the signals ① to ③ are positive, see red quadrants, *Figure 9*. The zero position is then calculated, where ① = MAX (90°), ② = ZERO (0°).

The reference signal form has no influence. It is important to highlight more than this one quadrant, but not more than one signal period.

- ① Output signal A
- ② Output signal B, 90° phase-offset from A
- ③ Reference signal Z

Figure 9
Reference signal position

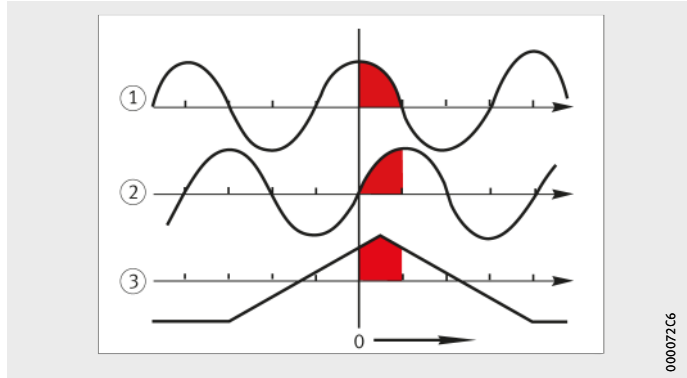

Special designs

The SRM electronic measuring system is also available as a single reference mark measuring system. Please state this in the order text.

Design and safety guidelines
Design of adjacent construction

The locating bore for the measuring head should have a chamfer $1 \times 30^\circ$; the lead chamfer for the O ring of the measuring head.

The measuring head should be centred in all planes on the shaft locating washer and secured against rotation by means of a locating surface.



For centring of the coded shaft locating washer, the bearing must be supported over its entire height by the adjacent construction of the shaft.

It is absolutely essential that the following are checked:

- The depth of the slot for the measuring heads conforms to dimension A, see table Recess diameter and distance and *Figure 10*, page 64.
- The screw mounting faces of the measuring heads are free from burrs and flat.
- The arrangement of the measuring heads is $180^\circ \pm 1^\circ$, *Figure 10*, page 64 and *Figure 11*, page 66.
- The recess diameter $D_{A \min}$ is machined in the adjacent construction for mounting of the bearing and the reliable function of the measuring system, see table.
- The distance F is maintained after the measuring heads are fitted, see table and *Figure 10*, page 64.
- The cable exit direction corresponds to the illustration, *Figure 10*, page 64 when using cables with 90° elbow plugs.
- Cables at the height of the measuring heads are relieved of tension. Especially where 90° elbow plugs are used, cable tension forces can lead to overloading of the plugs.

Recess diameter and distance

Axial/radial bearing Designation	Distance between sensor screw mounting surfaces and centre of bearing $A_{-0,4}$ mm	Recess diameter $D_{A \min}$ mm	Distance F mm $\pm 0,1$
YRTM150	132	215	22
YRTM180	147,2	245,5	25
YRTM200, YRTSM200	160,6	274,5	25
YRTM260, YRTSM260	196,9	345,5	29,75
YRTM325, YRTSM325	231,3	415,5	32,5
YRTM395, YRTSM395	267,5	486,5	33,75
YRTM460, YRTSM460	303,8	560,5	36,5



Axial/radial bearings with angular measuring system

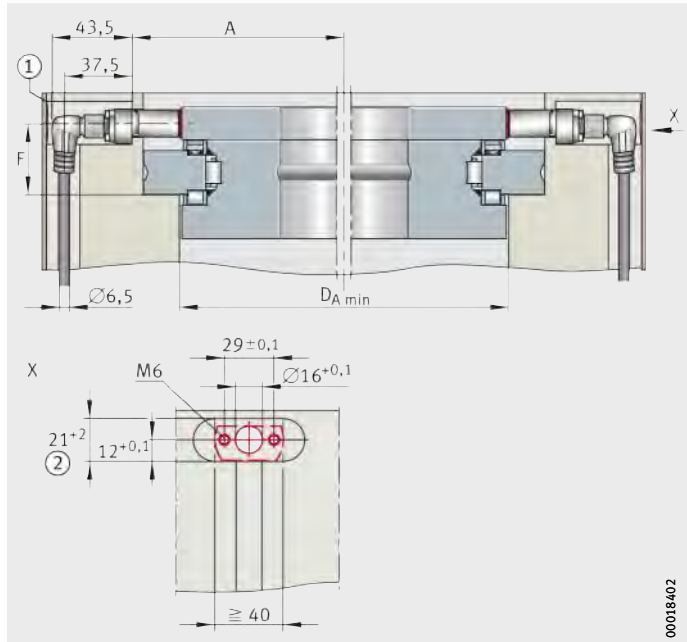

- ① Cover
- ② Fitting of a measuring head rotated by 180° (= no function) is not possible

Figure 10
Design of adjacent construction and diametrically opposed arrangement of measuring heads



If the measuring heads are located deep in the housing, they must be sufficiently accessible to allow setting of the measurement gap. The measuring heads and cable must be protected by a suitable cover against mechanical damage and long term contact with fluids. The positional orientation of the measuring heads is determined by the locating face. It is not sufficient to determine the positioning exclusively by means of the fixing screws. Observe the minimum bending radii for signal cables. Fluids must not be allowed to build up in the measuring head pockets (IP67).

Safety-related information about the measuring device under the terms of the Machinery Directive

The angular measuring system meets the described product characteristics when used correctly. The measuring system is not suitable for use in safety-related control circuits and should not be used for this purpose. For systems with a safety focus, the positional value of the measuring device must be checked after the higher level system has been switched on. The measuring device is not developed in accordance with IEC 61508 and no SIL classification exists.

Characteristics of the measuring device relevant to hazard analysis:

- The system does not have redundant functional elements.
- Software is involved in generating the output signals.
- If the following events occur, a zero voltage signal is outputted by the electronic evaluation system once the initial operation procedure that can be detected by a suitable electronic post-processing system as an error:
 - defect in the power supply
 - error in plausibility testing of the two measuring head signals by means of 4 quadrant operation (detection of measuring head failure or loose connections, for example cable breakage)
 - undershoot in the permissible minimum amplitudes (detection of measuring head failure, detection of an impermissibly large increase in the measurement gap, for example after a machine crash).



Axial/radial bearings with angular measuring system

Fitting

Due to the integrated dimensional scale and the small measuring heads designed for optimum use of available space, the measuring system is very easy to install.

Fitting guidelines for the axial/radial bearing

During fitting, the coded shaft locating washer is centred precisely by means of the shaft journal manufactured precisely over the whole bearing height.

Before fitting, the retaining screws on the inner ring should be loosened so that the bearing inner ring and shaft locating washer with the dimensional scale can align and centre themselves to each other without any force.



Do not use magnetised tools.

The magnetic dimensional scale has a protective strip for transport and fitting.

Do not remove the protective strip until after the bearing is fitted.

Note the additional information on fitting of axial/radial bearings YRTM or YRTSM, see TPI 103, High precision bearings for combined loads.

Fitting guidelines for measuring heads

The mounting position of the measuring heads is specified by the design of the locating pockets.

Diametrically opposed arrangement of measuring heads

The arrangement of the measuring heads must not be smaller or greater than a diametrically opposed arrangement of $180^\circ \pm 1^\circ$, otherwise any eccentricities in the shaft locating washer will affect the measurement accuracy, *Figure 10*, page 64 and *Figure 11*.

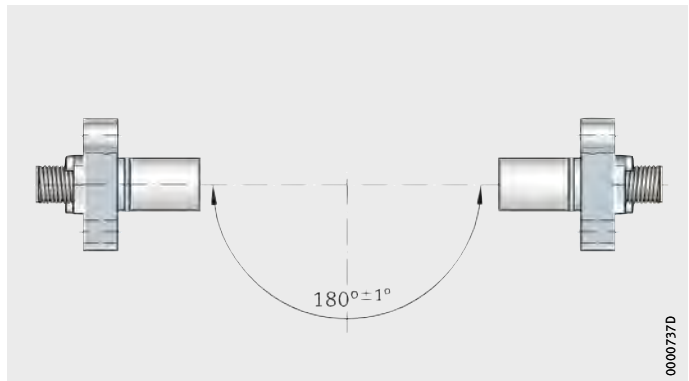

Figure 11
Diametrically opposed
arrangement of measuring heads

Fitting of measuring heads

First set the measuring heads using the MEKOEDS software and the shims supplied to the correct distance from the outside diameter of the shaft locating washer, *Figure 12* and page 50. Setting: see MON 18, Axial/radial bearings with angular measuring system.

The software is then used to carry out a Teach-In process that matches the measuring heads to the electronic evaluation system.



Tighten the fixing screws carefully. Do not exceed an amplitude display of 80% in the MEKOEDS software during setting. The sensor surface of the measuring head must only be subjected to load by hand pressure. Forces > 50 N may damage the sensor surface.

The fixing screws for the measuring heads must be secured using Loctite (such that they can be removed again), *Figure 12*.

Maximum screw tightening torque $M_A = 10 \text{ Nm}$.

- ① Shim
- ② Sealing ring
- ③ Fixing screws

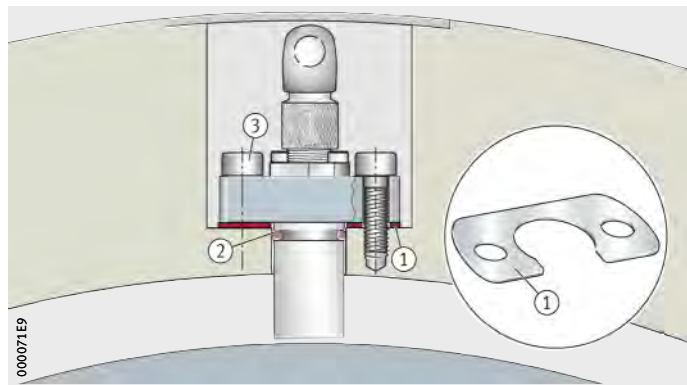

Figure 12
Fitting of measuring head

Cables and plugs for signal transmission

The plugs for the input signals to the electronic evaluation system are of an 8 pin type.

At first Teach-In, the system automatically detects which measuring head (white or yellow) is connected to which input.



The measuring heads, plugs and cables must be protected from mechanical damage.



Axial/radial bearings with angular measuring system

Ordering example, ordering designation

An axial/radial bearing of size 395 is required with measuring system, *Figure 13*.

Unit

The unit comprises:

Axial/radial bearing

YRTSM395

Electronic measuring system

SRM01

Two connection cables with 90° elbow plugs on the measuring head side for connecting to the electronic evaluation system, each cable 2 m long

SRMC2-A

Ordering designation

YRTSM395/SRM01/(2 pieces) SRMC2-A



Two cables must be ordered for each measuring system unit.

- ① YRTSM395
- ② Measuring heads
- ③ Shims
- ④ Electronic evaluation system
- ⑤ Connection cables

Figure 13
Ordering example,
ordering designation:
Unit

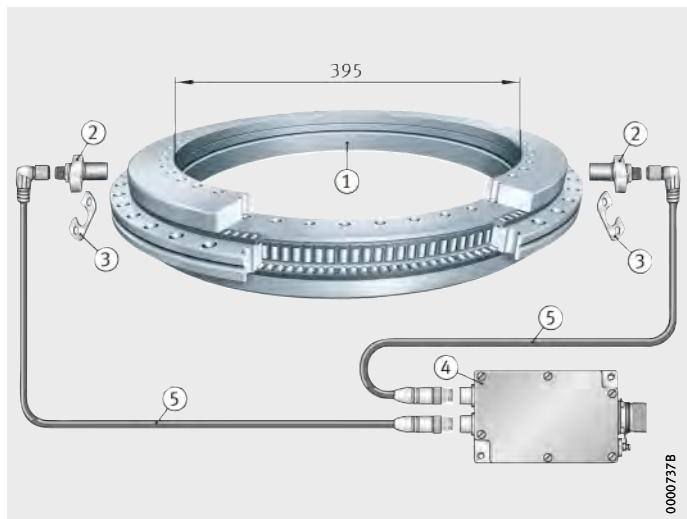

Also required... The following are also required:

setting and diagnosis software (USB memory stick with interface cable, 5 m, can be used as often as required)	MEKOEDS
fitting and maintenance manual for the bearing	TPI 103
Teach-In and diagnosis manual for the measuring system	MON 18

Both manuals are held on the USB memory stick as PDF files.

Ordering designation **MEKOEDS**

The manuals TPI 103, High precision bearings for combined loads, and MON 18, Axial/radial bearings with angular measuring system, can also be obtained in printed form from Schaeffler.

Replacement parts The following replacement parts are available, *Figure 13*, page 68:

Only shaft locating washer with coding	WSM YRT >bearing bore diameter<
Measuring head with reference sensor (yellow)	SRMH ye
Measuring head without reference sensor (white)	SRMH wh
Shims (packet)	SS-SRM
Electronic evaluation system	SRMB



Axial/radial bearings

Double direction
With measuring system

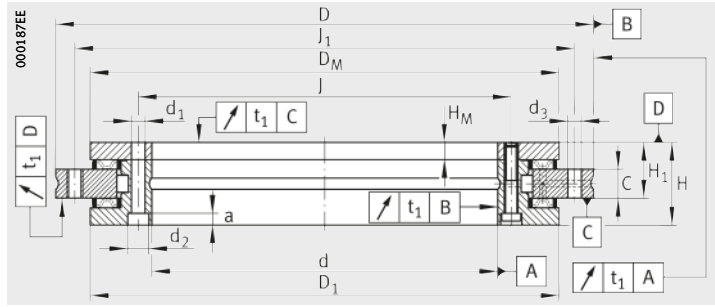

YRTM

Dimension table - Dimensions in mm

Designation	Mass m ≈kg	Dimensions										Fixing holes					
		d	D	H	H ₁	H _M	C	D _M	D ₁	J	J ₁	Inner ring			Outer ring		
												d ₁	d ₂	a	Quantity ⁴⁾	d ₃	Quantity ⁴⁾
YRTM150 ⁶⁾	6,4	150	240	41 ⁷⁾	27 ⁷⁾	10	12	214	214	165	225	7	11	6,2	34	7	33
YRTM180 ⁶⁾	7,7	180	280	44 ⁷⁾	30 ⁷⁾	10	15	244,5	244	194	260	7	11	6,2	46	7	45
YRTM200 ⁶⁾	9,7	200	300	45	30	10	15	271,2	274	215	285	7	11	6,2	46	7	45
YRTM260	18,3	260	385	55	36,5	13,5	18	343,8	345	280	365	9,3	15	8,2	34	9,3	33
YRTM325 ⁵⁾	25	325	450	60	40	15	20	412,6	415	342	430	9,3	15	8,2	34	9,3	33
YRTM395	33	395	525	65	42,5	17,5	20	485,5	486	415	505	9,3	15	8,2	46	9,3	45
YRTM460	45	460	600	70	46	19	22	557,7	560	482	580	9,3	15	8,2	46	9,3	45

1) Including retaining screws or threaded extraction holes.

2) Tightening torque for screws to DIN 912, grade 10.9.

3) Rigidity values taking account of the rolling element set, deformation of the bearing rings and the screw connections.

4) Attention!
For fixing holes in the adjacent construction. Note the pitch of the bearing holes.

5) Screw counterbores in the L-section ring open to the bearing bore.
The bearing inside diameter is unsupported in the area ②.

6) The measuring head cannot be mounted between the fixing holes or the heads of the fixing screws.
Two holes for fixing screws therefore remain unused in the bearing outer ring.

7) Attention!
H and H₁ are 1 mm higher than standard bearings YRT.

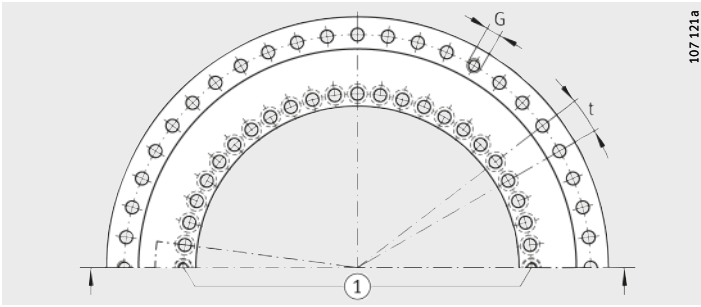

Hole pattern

① Two retaining screws

Pitch $t^{1)}$	Threaded extraction hole		Screw tightening torque $M_A^{2)}$ Nm	Basic load ratings				Bearing frictional torque M_R Nm	Axial rigidity ³⁾ c_{aL} kN/ μ m	Radial rigidity ³⁾ c_{rL} kN/ μ m	Tilting rigidity ³⁾ c_{kL} kNm/mrad		
	Quantity	Xt		G	Quantity	axial						radial	
						dyn. C N	stat. C ₀ N					dyn. C N	stat. C ₀ N
36X10°	M8	3	14	85 000	510 000	77 000	179 000	13	2,3	2,6	11		
48X7,5°	M8	3	14	92 000	580 000	83 000	209 000	14	2,6	3	17		
48X7,5°	M8	3	14	98 000	650 000	89 000	236 000	15	3	3,5	23		
36X10°	M12	3	34	109 000	810 000	102 000	310 000	25	3,5	4,5	45		
36X10°	M12	3	34	186 000	1 710 000	134 000	415 000	48	4,3	5	80		
48X7,5°	M12	3	34	202 000	2 010 000	133 000	435 000	55	4,9	6	130		
48X7,5°	M12	3	34	217 000	2 300 000	187 000	650 000	70	5,7	7	200		

Limiting speeds

for bearing YRTM and SRM measuring system

Designation	Limiting speed	
	Electronic evaluation system and bearing n_G min^{-1}	Reference travel n_{Ref} min^{-1}
YRTM150	210	35
YRTM180	190	30
YRTM200	170	30
YRTM260	130	25
YRTM325	110	25
YRTM395	90	15
YRTM460	80	15

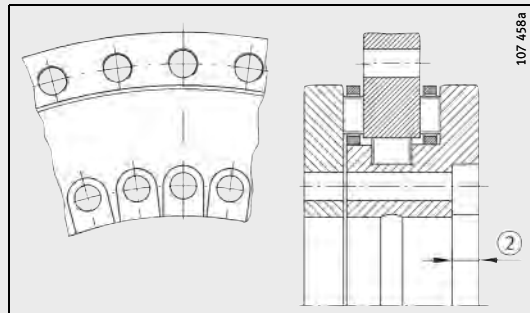

Screw counterbore open
Bearing inside diameter unsupported in area ②



Axial/radial bearings

Double direction
With measuring system

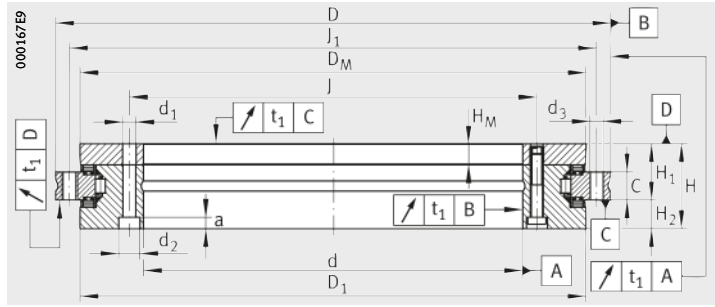

YRTSM

Dimension table - Dimensions in mm

Designation	Mass m ≈kg	Dimensions										
		d	D	H	H ₁	H _M	H ₂	C	D ₁	D _M	J	J ₁
YRTSM200 ⁶⁾	9,7	200	300	45	30	10	15	15	274	271,2	215	285
YRTSM260	18,3	260	385	55	36,5	13,5	18,5	18	345	343,8	280	365
YRTSM325 ⁵⁾	25	325	450	60	40	15	20	20	415	412,6	342	430
YRTSM395	33	395	525	65	42,5	17,5	22,5	20	486	485,5	415	505
YRTSM460	45	460	600	70	46	19	24	22	560	557,7	482	580

- 1) Including retaining screws or threaded extraction holes.
- 2) For screws to DIN 912, grade 10.9.
- 3) Attention!
For fixing holes in the adjacent construction.
Note the pitch of the bearing holes.
- 4) Rigidity values taking account of the rolling element set,
deformation of the bearing rings and the screw connections.
- 5) Screw counterbores in the L-section ring open to the bearing bore.
The bearing inside diameter is unsupported in the area ②.
- 6) The measuring head cannot be mounted between the fixing holes or the heads of the fixing screws.
Two holes for fixing screws therefore remain unused in the bearing outer ring.

Dimension table (continued)

Designation	Basic load ratings				Rigidity of bearing position ⁴⁾		Tilting rigidity ⁴⁾ c _{kL} kNm/mrad
	axial		radial		axial	radial	
	dyn. C _a N	stat. C _{0a} N	dyn. C N	stat. C ₀ N	c _{aL} kN/μm	c _{rL} kN/μm	
YRTSM200 ⁶⁾	155 000	840 000	94 000	226 000	4	1,2	29
YRTSM260	173 000	1 050 000	110 000	305 000	5,4	1,6	67
YRTSM325 ⁵⁾	191 000	1 260 000	109 000	320 000	6,6	1,8	115
YRTSM395	214 000	1 540 000	121 000	390 000	7,8	2	195
YRTSM460	221 000	1 690 000	168 000	570 000	8,9	1,8	280

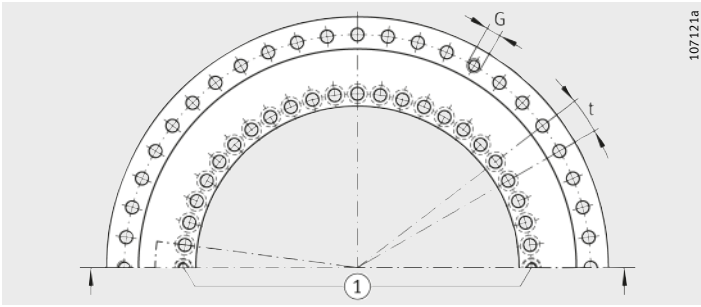

Hole pattern

① Two retaining screws

Fixing holes					Retaining screws Quantity	Pitch $t^{1)}$ QuantityXt	Threaded extraction hole		Screw tightening torque $M_A^{2)}$ Nm
Inner ring			Outer ring				G	Quantity	
d_1	d_2	a	d_3	Quantity ³⁾					
7	11	6,2	7	45	2	48X7,5°	M8	3	14
9,3	15	8,2	9,3	33	2	36X10°	M12	3	34
9,3	15	8,2 ⁵⁾	9,3	33	2	36X10°	M12	3	34
9,3	15	8,2	9,3	45	2	48X7,5°	M12	3	34
9,3	15	8,2	9,3	45	2	48X7,5°	M12	3	34

Limiting speeds

for bearing YRTSM and SRM measuring system

Designation	Limiting speed	
	Electronic evaluation system and bearing n_G min^{-1}	Reference travel n_{Ref} min^{-1}
YRTSM200	1 160	30
YRTSM260	910	25
YRTSM325	760	25
YRTSM395	650	15
YRTSM460	560	15

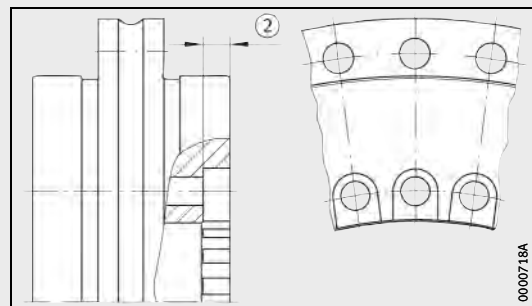

Screw counterbore open⁵⁾

Bearing inside diameter unsupported in area ②



SRM electronic measuring system

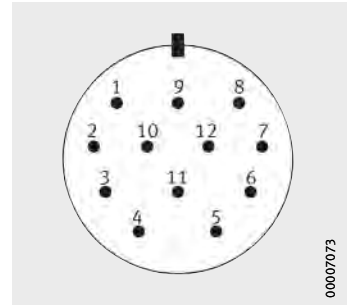

Plug configuration of 12 pin flanged plug

Plug configuration of 12-pin flanged plug

5	6	8	1	3	4	12	10	2	11	9	7	/
A		B		R		5 V (U_p)	0 V (U_N)	5 V (feeler)	0 V (feeler)	free	/	free
+	-	+	-	+	-	-	-	-	-	-	-	-
-	-	-	-	-	-	IEC 747 EN 50 178		-	-	-	-	-

The feeler cables are connected internally to the supply cable (2 with 12 and 11 with 10). They are used by the motor controller as a measurement cable in order to compensate the voltage drop on the supply cable (four-wire principle). If this function is not supported by the controller used, the two 5-V cables and both 0-V cables can be wired in parallel in order to reduce the voltage drop on the supply lead. The housing is shielded.

Electronic evaluation system (protection class IP67):

- ① Connection for RS232
- ② 2 holes for fixing screws DIN 912-M4×10
- ③ Shielded plug with cable to electronic post-processing system (not included in delivery).

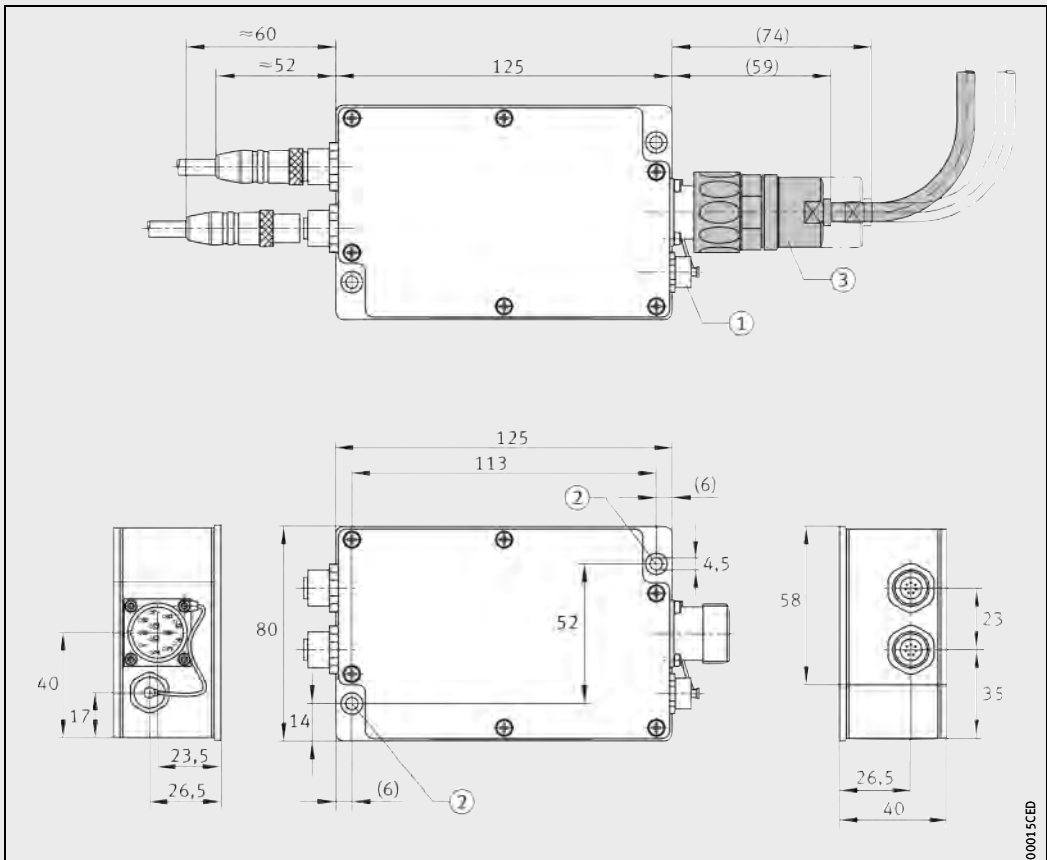

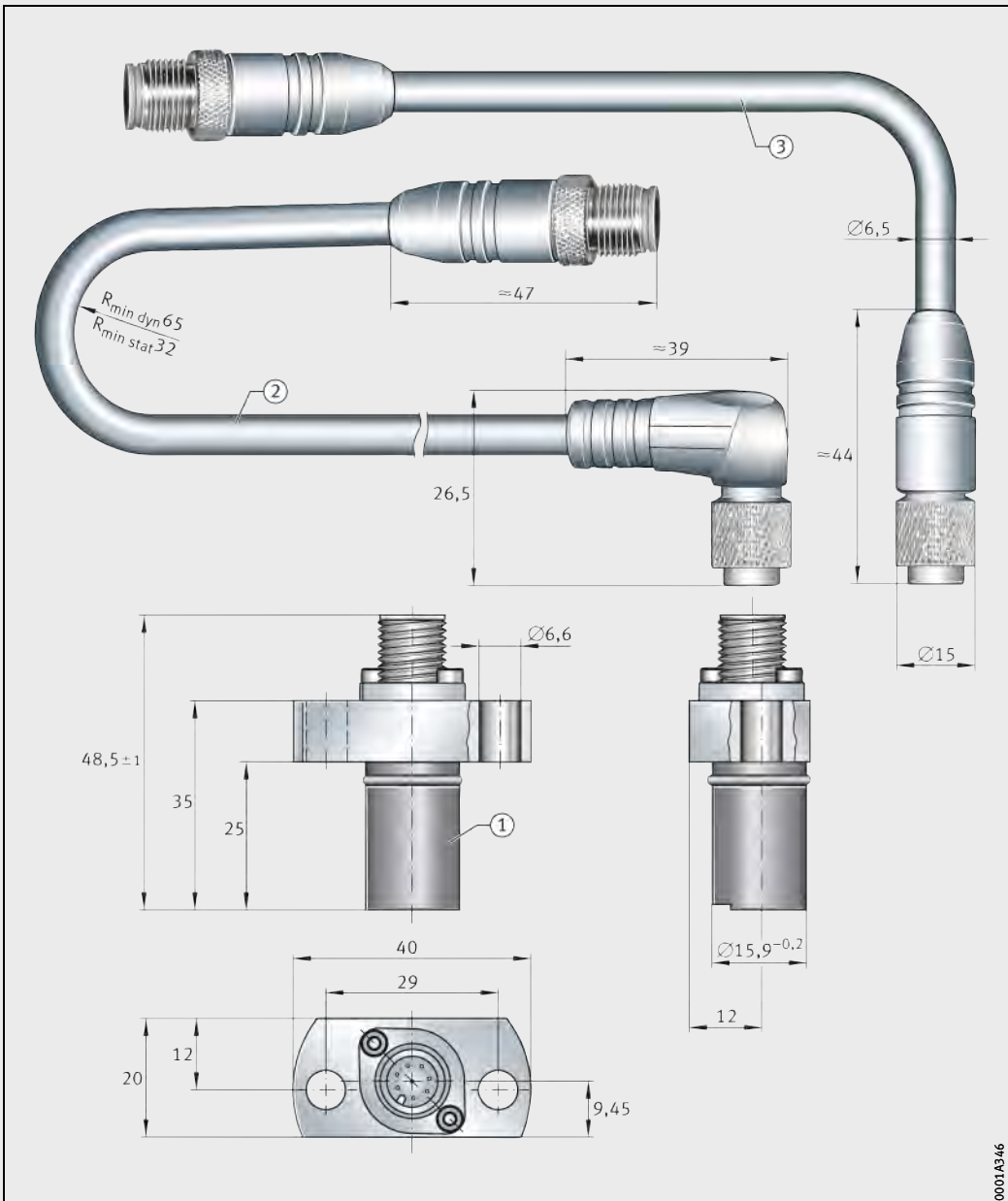

0001.A314

Measuring head ①, connection cable SRMC..-A ② and SRMC..-S ③.
 (Design of connection cable: see page 49)



Notes

**Schaeffler Technologies
AG & Co. KG**

Industriestraße 1–3
91074 Herzogenaurach
Germany
Internet www.ina.com
E-mail info.de@schaeffler.com

In Germany:

Phone 0180 5003872
Fax 0180 5003873

From other countries:

Phone +49 9132 82-0
Fax +49 9132 82-4950

**Schaeffler Technologies
AG & Co. KG**

Georg-Schäfer-Straße 30
97421 Schweinfurt
Germany
Internet www.fag.com
E-mail faginfo@schaeffler.com

In Germany:

Phone 0180 5003872
Fax 0180 5003873

From other countries:

Phone +49 9721 91-0
Fax +49 9721 91-3435

Every care has been taken to ensure the correctness of the information contained in this publication but no liability can be accepted for any errors or omissions. We reserve the right to make technical changes.

© Schaeffler Technologies AG & Co. KG
Issued: 2013, September

This publication or parts thereof may not be reproduced without our permission.
TPI 120 GB-D